

IMPORTANT NOTICE

All rights to this manual are owned solely by SATEL Oy (referred to in this user guide as SATEL). All rights reserved. The copying of this manual (without the written permission from the owner) by printing, copying, recording or by any other means, or the full or partial translation of the manual to any other language, including all programming languages, using any electrical, mechanical, magnetic, optical, manual or other methods or devices is forbidden.

SATEL reserves the right to change the technical specifications or functions of its products, or to discontinue the manufacture of any of its products or to discontinue the support of any of its products, without any written announcement and urges its customers to ensure, that the information at their disposal is valid.

SATEL software and programs are delivered "as is". The manufacturer does not grant any kind of warranty including guarantees on suitability and applicability to a certain application. Under no circumstances is the manufacturer or the developer of a program responsible for any possible damages caused by the use of a program. The names of the programs as well as all copyrights relating to the programs are the sole property of SATEL. Any transfer, licensing to a third party, leasing, renting, transportation, copying, editing, translating, modifying into another programming language or reverse engineering for any intent is forbidden without the written consent of SATEL.

SATEL PRODUCTS HAVE NOT BEEN DESIGNED, INTENDED NOR INSPECTED TO BE USED IN ANY LIFE SUPPORT RELATED DEVICE OR SYSTEM RELATED FUNCTION NOR AS A PART OF ANY OTHER CRITICAL SYSTEM AND ARE GRANTED NO FUNCTIONAL WARRANTY IF THEY ARE USED IN ANY OF THE APPLICATIONS MENTIONED.

NOTE: This equipment has been tested and found to comply with the limits for a Class A digital device, pursuant to Part 15 of the FCC Rules. These limits are designed to provide reasonable protection against harmful interference when the equipment is operated in a commercial environment. This equipment generates, uses, and can radiate radio frequency energy and, if not installed and used in accordance with the instruction manual, may cause harmful interference to radio communications. Operation of this equipment in a residential area is likely to cause harmful interference in which case the user will be required to correct the interference at his own expense.

Salo, FINLAND 2019

Copyright: 2019 SATEL Oy

No part of this document may be reproduced, transmitted or stored in a retrieval system in any form or by any means without the prior written permission of SATEL Oy.

RESTRICTIONS ON USE

SATELLINE-4Pro radio modems have been designed to operate on frequency ranges, the exact use of which differs from one region and/or country to another. The user of a radio modem must take care that the said device is not operated without the permission of the local authorities on frequencies other than those specifically reserved and intended for use without a specific permit.

The allowed max output power depends on the type of station.

SATELLINE-4Pro is allowed to be used in the following countries, either on licence free channels or on channels where the operation requires a licence. More detailed information is available at the local frequency management authority.

Countries: BR, CA, RU and US.

WARNING - RF Exposure

To comply with RF exposure compliance requirements of CFR Part 47, §1.1310, a separation distance of at least 2.59 m must be maintained between the antenna of this device and all persons. To comply with RF exposure compliance requirements of RSS-102 Issue 5, a separation distance of at least 3.38 m must be maintained between the antenna of this device and all persons. This device must not be co-located or operating in conjunction with any other antenna or transmitter.

PRODUCT CONFORMITY

SATELLINE-4Pro complies with the following standards:

- RSS 119, issue 12
- FCC Part 90

WARRANTY AND SAFETY INSTRUCTIONS

Read these safety instructions carefully before using the product:

-Warranty will be void, if the product is used in any way that is in contradiction with the instructions given in this manual, or if the radio modem housing has been opened or tampered with.

-The radio modem is only to be operated at frequencies allocated by local authorities, and without exceeding the given maximum allowed output power ratings. SATEL and its distributors are not responsible, if any products manufactured by it are used in unlawful ways.

-The devices mentioned in this manual are to be used only according to the instructions described in this manual. Faultless and safe operation of the devices can be guaranteed only if the transport, storage, operation and handling of the devices are appropriate. This also applies to the maintenance of the products.

-To prevent damage both the radio modem and any terminal devices must always be switched OFF before connecting or disconnecting the serial connection cable. It should be ascertained that different devices used have the same ground potential. Before connecting any power cables the output voltage of the power supply should be checked.

-If the device uses an outdoor antenna, the antenna cable jacket must be grounded.

TABLE OF CONTENTS

IMPORTANT NOTICE	1
RESTRICTIONS ON USE	2
PRODUCT CONFORMITY.....	3
WARRANTY AND SAFETY INSTRUCTIONS	4
TABLE OF CONTENTS	5
INTRODUCTION	9
1 SATELLINE-4PRO TECHNICAL SPECIFICATIONS	10
1.1 Default settings	12
2 OTHER FEATURES	13
3 SATELLINE-4PRO SPECIAL FEATURES	14
3.1 Call Sign	14
3.2 Temperature protection of RF power amplifier	14
3.3 Protection of current	15
4 SERIAL INTERFACE	16
5 USER INTERFACE.....	17
5.1 LED-indicators	17
5.2 Display and push buttons	17
5.2.1 SATELLINE-4Pro LCD-display after power-up.....	18
6 CONNECTION INTERFACES	20
6.1 RS-232 interface.....	20
6.2 Connectors.....	20
7 RF INTERFACE	22

7.1	Transmitter.....	22
7.2	Receiver.....	23
7.3	Priority RX/TX.....	23
7.4	Forward Error Correction	24
7.5	Error checking	24
7.6	Dual radio function, separate RX/TX-frequencies	24
7.7	User data whitening	25
7.8	Pacific Crest, TRIMTALK and SOUTH compatibility	25
7.8.1	General.....	25
7.8.2	Configuration by using SL commands	26
7.8.3	Settings	26
7.8.4	Repeater function.....	29
7.8.5	Support for Local / Remote addresses	29
7.8.6	Latency.....	30
7.8.6.1	Transmission delays using Pacific Crest 4FSK on 25 kHz channel.....	30
7.8.6.2	Transmission delays using Pacific Crest GMSK on 25 kHz channel.....	30
8	TRANSPARENT DATA TRANSMISSION	31
8.1	Serial interface, data format	31
8.2	Handshake lines	31
8.2.1	CTS-line	32
8.2.2	RTS-line.....	32
8.3	Timing and delays during data transmission	32
8.3.1	Data buffering in the radio data modem.....	33
8.3.2	Pause length	33
8.3.3	TX delay	34
8.4	Testing	34
9	SETTINGS.....	36
9.1	Changing the in use channel using the LCD-display.....	36
9.1.1	Viewing the set Channel List –settings.....	37
9.1.1	LCD UI Info.....	38
9.1.2	Saving modified values into the internal memory	39
9.2	Changing parameters using the SL-commands	39
9.2.1	Frequency.....	40
9.2.2	Addressing.....	41
9.2.3	Radio parameters	41

9.2.4	Other functions	42
10	REPEATER MODE AND ADDRESSING	43
10.1	Repeater.....	43
10.2	Addressing	44
10.2.1	Connection between two points.....	46
10.2.2	System of one base station and several substations	46
10.3	Using repeaters and addresses in the same system.....	47
10.3.1	System with several repeaters	47
10.3.2	Repeater chain using address pairs	48
10.3.3	Repeater chain using dual addressing	49
10.3.4	Redundant repeater chain.....	49
11	INSTALLATION	50
11.1	Installation of a Radio Data Modem	50
11.1.1	RS-232 Wiring	50
11.1.2	Fuse.....	51
11.1.3	Power supply.....	51
11.2	Antenna installation	52
11.2.1	Mobile equipment.....	52
11.2.2	Base stations	52
11.2.3	General antenna installation instructions	52
12	DESIGNING SYSTEMS.....	56
12.1	Factors affecting the quality and distance of the radio connection	56
12.2	Radio field strength	57
13	CHECK LIST	58
14	ACCESSORIES.....	59
14.1	RS-232 cables and adapters.....	59
14.2	Power cables and supply	59
14.3	RF-cables	59
14.4	Antennas	60
14.5	Filters and lightning protectors	60
15	APPENDIX A	61

16	APPENDIX B	62
16.1	Functional delays	62
16.2	Transmission related delays	62
16.2.1	Transmission delays when the radio TX frequency is changed	63
16.2.2	Transmission delays when using a 12.5 kHz radio channel	63
16.2.3	Transmission delays using a 25 kHz radio channel	65

INTRODUCTION

SATEL Oy is a Finnish electronics and Telecommunications Company specialising in the design and manufacture of wireless data communication products. SATEL designs, manufactures and sells radio modems intended for use in applications ranging from data transfer to alarm relay systems. End users of SATEL products include both public organisations and private individuals.

SATEL Oy is the leading European manufacturer of radio modems. SATEL radio modems have been certified in most European countries and also in many non-European countries.

SATELLINE-4Pro is an IP67 classified UHF radio modem with a high power (35 W) transmitter, wide tuning range (406.180 ... 470 MHz) in one hardware and selectable channel spacing. The SATELLINE-4Pro can offer radio speeds up to 28800 bps and has a selectable serial interface speed between 9600 ... 115200 bps.

SATELLINE-4Pro contains push buttons and a LCD-display, which can be used to modify the pre-defined channel lists, created with SATEL Configuration Manager PC-program. Setting the channel list into use with channel list information is required before the device can be used. Additional information regarding the Configuration Manager PC-program can be found from the SW user manual.

The radio modem also offers option of error correction, utilising the FEC-method (Forward Error Correction). FEC can be used to minimise errors caused by noisy channels.

1 SATELLINE-4Pro TECHNICAL SPECIFICATIONS

SATELLINE-4Pro complies with the following international standards:

- o FCC CFR47 part 90
- o RSS-119 Issue 12

	RECEIVER	TRANSMITTER	Note!
Frequency Range	406.180 ... 470 MHz		
Tuning Range	63.82 MHz		
Channel Spacing	12.5 kHz / 25 kHz		Programmable
Spurious Radiations	According to FCC CFR47 part 90		
Duty Cycle 35W *)	100% (@22°C) 20 min 100% (@35 °C) 13 min 40% No limit		
Duty Cycle 10W *)	100% (@22°C) No limit 100% (@35 °C) 50 min 40% No limit		
Frequency Error Tolerance	< 1 kHz		
Sensitivity	4FSK -117 dBm @ 12.5 kHz -116 dBm @ 25 kHz 8FSK -115 dBm @ 12.5 kHz -114 dBm @ 25 kHz 16FSK -108 dBm @ 12.5 kHz -106 dBm @ 25 kHz		FEC ON BER < 10 E-3
Co-channel Rejection	> -12 dB		4FSK FEC ON
Adjacent Channel Selectivity	> 47 dB @12.5 kHz > 53 dB @ 25 kHz		4FSK FEC ON
Intermodulation Response Rejection	> -49 dBm		4FSK FEC ON
Blocking	> 86 dB		4FSK FEC ON
Spurious Response Rejection	> -38 dBm		4FSK FEC ON
Power Consumption	< 1.8 W	120 W typical @ 35 W, min. 12 Vdc 100 W typical @ 25W	
Power Save Mode Consumption	SLEEP State: 0.4 W typical		
Communication Mode	Half-Duplex		
Type of Emission	F1D		
Carrier power	2, 10, 20, 25, 35 W / 50 ohm		
Carrier power stability	+ 1 dB / - 1 dB		

*) If high output power is used continuously or with a high cycle, the equipment generates excess heat. The output power is automatically decreased when necessary to prevent overheating. Typical operating times are shown in the chart with different output powers and duty cycles @ 22°C and 35 °C (see chapter 3.2).

	DATA MODEM	
Timing	RS-232	
Electrical Interface	RS-232	
Interface Connector	8-pin ODU	
Data speed of I/O-interface	9600 – 115200 bps	
Data speed of Radio Interface	Up to 28800 bps (25 kHz channel) / Up to 14400 bps (12.5 kHz channel)	
Data Formats	Asynchronous RS-232	
Modulation	4FSK, 8FSK, 16FSK, GMSK (PacificCrest, TRIMTALK **)	

**) TRIMTALK is a trademark of Trimble Navigation Ltd.

	GENERAL	
DC input range	Nominal voltage : +9...+16 V _{DC}	4-pin ODU MINI-Snap Size 1
Temperature Ranges	-30 °C...+60 °C	Complies with standards
	-40 °C...+75 °C (absolute min / max)	Functional
	-40 °C... +85°C	Storage
Antenna Connector	TNC, 50 ohm, female	
Construction	Aluminium housing	
Size L x W x T	189 x 138 x 71 mm (with connectors)	
Weight	1420g	
IP Classification	IP67 (NEMA 6)	

1.1 Default settings

SATELLINE-4Pro is shipped with the following default settings (unless otherwise specifically agreed):

DEFAULT VALUES OF THE ADJUSTABLE SETTINGS (user can change settings later on)		
Setting	Default value	Range
Radio frequency		
Operating TX frequency	430.000 MHz	Range: 406.180 – 470.000 MHz
Operating RX frequency	430.000 MHz	Range: 406.180 – 470.000 MHz
Reference Frequency	430.000 MHz	Range: 406.180 – 470.000 MHz
Channel Spacing	12.5 kHz	Range: 12.5 or 25 kHz
Radio settings		
Tx Power	35 W	Range: 2, 10, 20, 25 and 35 W
Signal threshold	-115 dBm	-80 ... -118 dBm
FCS	OFF	ON/OFF
Tx-Start Delay	0 ms	0-65535 ms
Radio Compatibility	SATEL-8FSK-1	SATELLINE-3AS PacCrest-4FSK PacCrest-GMSK TrimTalk450s(P) TrimTalk450s(T) PacCrest-FST SOUTH SATEL-8FSK-1 (FEC OFF) SATEL-8FSK-2 (FEC ON) SATEL-16FSK-1 (FEC ON)
Addressing		
RX Address	OFF	ON/OFF
TX Address	OFF	ON/OFF
RX addressing to RS port	OFF	ON/OFF
TX address auto switch	OFF	ON/OFF
Serial port 1		
Status	ON	ON/OFF
Interface	RS-232	Fixed
Data speed	115200 bps	9600, 19200, 38400, 57600, 115200 bps
Data bits	8	8
Parity bits	None	None, Even, Odd
Stop bits	1	1
Handshaking		
CTS	Clear to send	Clear to send, TX buffer state
RTS	Ignored	Ignored, Flow Control, Reception Control
Pause length	3 bytes	3 ... 255 bytes
Additional setup		
Error correction	OFF	ON/OFF
Error check	OFF	ON/OFF
Repeater	OFF	ON/OFF
SL-commands	ON	ON/OFF
Priority	TX	RX/TX
FullCR16 Check	OFF	ON/OFF
Tests	OFF	ON/OFF

The power cable (+V_b and GND) must be connected to a power supply with a proper output voltage (+9...+16 V_{DC}) and with a minimum output current of 15A.

2 OTHER FEATURES

SATELLINE-4Pro radio modem fulfils the IP67 (NEMA 6) standard. With an IP67 rating a product will be totally protected against dust and remain completely sealed when immersed in water to a depth between 15 cm and 1 meter.

SATELLINE-4Pro modem is equipped with a high power 35W transmitter. It is designed for easy mobile use in demanding field conditions.

The SATELLINE-4Pro is equipped with a liquid crystal display (LCD) and a keypad, used to indicate the current operating status, as well as for changing the operating channel and power level of the radio modem.

3 SATELLINE-4Pro SPECIAL FEATURES

3.1 Call Sign

SATELLINE-4Pro has a CALL SIGN identifier -feature required in some countries. A call sign can be formally assigned by a government agency, informally adopted by individuals or organizations, or even cryptographically encoded to disguise identity of a station.

A call sign is an FCC (in US) or other regulatory authority assigned identifier that is issued along with the license for operating a radio modem. This field is for entering your call sign. The modem automatically broadcasts the specified call sign periodically. If this field is empty, there is no call sign information.

Call sign setup can be found in Modem settings –menu on SATEL Configuration Manager PC-program, sub clause *Call Sign*. Call sign has three (3) different setups. With **Call Sign Mode** you can set Morse code transmission ON or OFF. **Call Sign ID** defines which Morse code will be transmitted. Only capital letters and numbers are allowed. If the digits are wrong kind, there will be message: *Value error*. Small letters will be converted to capital letters automatically. If **Call Sign ID** field remains empty, the Call Sign transmission will not be activated. **Call Sign Timer** is the transmission delay of Morse codes. Minimum and default transmission time is 15 minutes.

During Call sign transmission the CTS-line of the modem is not in active state. This is to inform terminal equipment that the modem is not ready to neither receive data from serial port nor forward it. The modem deletes all data (also SL commands), which has arrived to serial port during call sign transmission. Call sign transmission lasts 1-4 seconds depending on the number of digits.

3.2 Temperature protection of RF power amplifier

RF power amplifier is protected against overheating. The power of transmitter is lowered step by step if the inner temperature exceeds certain levels as shown below.

Temperature inside a modem	Carrier power
Over 75°C	25 W
78°C	20 W
80°C	10 W
85°C	2 W
90°C	0 W (transmitter OFF)

When the ambient temperature is under 30°C and transmitter duty cycle does not exceed 40%, the temperature inside the modem does not exceed the trigger level.

The internal temperature is measured in the beginning of every transmission and at once when modem cools down. The carrier power increases with falling temperature so that at 85°C carrier power goes to 2W, at 80°C to 10W, at 78°C to 20W, at 75°C to 25W and at 73°C the modem operates again at the full 35W carrier power.

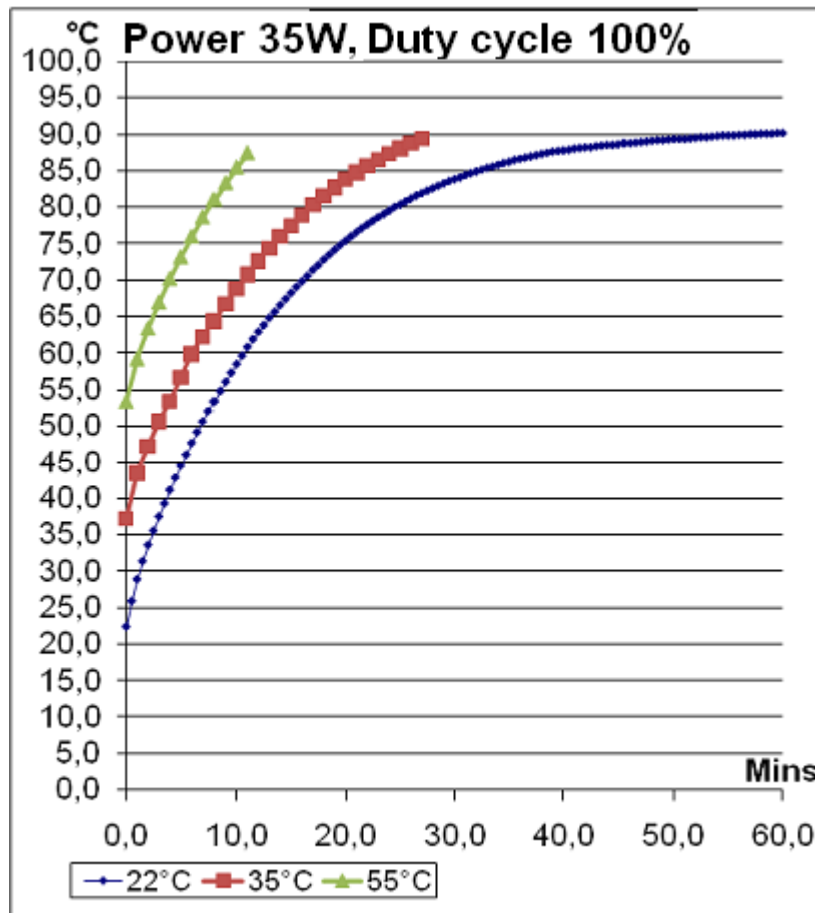

3.3 Protection of current

In case of a bad antenna impedance matching the current consumption of the Power Amplifier may be too high. For this reason the maximum current is limited to 12 A. If the current tends to increase over 12 A, the automatic power control decreases the power level until the current drops under 11.5 A. LCD indicates the actual power level of the transmitter. A new transmission starts always with the nominal power level. The power control scheme is applied only when the nominal power level is 35 W.

4 SERIAL INTERFACE

The radio modem is referred to as DCE (Data Communication Equipment) whereas the PC is referred to as DTE (Data Terminal Equipment). SATELLINE-4Pro includes a 8 pin ODU which contains all the connections required to establish communication between the radio modem, acting as the DCE, and the PC, acting as the DTE.

All EMC-requirements set forth by authorities have been taken into account in the design of the radio modem. The radio modem user is thereby not required to take any special actions regarding EMC-shielding (of the radio modem).

The radio modem has one serial port, **Port 1** which complies with the RS-232 standard.

Signal	8-pin ODU
RD	4
TD	5
CTS	2
RTS	1
GND	3

Description of pins:

- *RD* = **R**eceive **D**ata. Output of the data received from the radio modem to the DTE.
- *TD* = **T**ransmit **D**ata. Input of the data to be transmitted from the DTE to the radio modem.
- *CTS* = **C**lear **T**o **S**end.
- *RTS* = **R**equest **T**o **S**end.
- *GND* = both the negative pole of the operating voltage and the signal ground.

5 USER INTERFACE

5.1 LED-indicators

There are five (5) LED indicators on the front panel of the radio modem, and they give an indication of the status of the serial port and the radio interface:

Description of the LED-indicators:

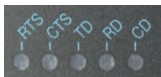

LED	Indication	OFF	Red	Orange	Green
RTS	RTS-line status	Inactive	Active		
CTS	CTS-line status	Inactive	Active		
TD	TD-line status	No data	Data		
RD	RD-line status	No data	Data		
CD	Radio status	No signal	Transmission (continuous = test Tx active)	Noise	Reception

5.2 Display and push buttons

SATELLINE-4Pro contains push buttons and a LCD-display, which can be used to modify the pre-defined channel lists, created with SATEL Configuration Manager PC-program.

NOTE! Setting the channel list into use with channel list information is required before the device can be used. Additional information regarding the Configuration Manager PC-program can be found from the SW user manual.

In case no channels are defined to the device, following text will be displayed in the LCD UI after entering to the menu with SETUP-button.

```
ERROR !!!
Channel list
Empty
```

SATELLINE-4Pro includes a LCD-display with a backlight. The display backlight illuminates automatically as soon as a button is pressed. In the *Data Transfer Mode* the display will show the operating settings of the radio modem, for example the radio field strength and the supply voltage. By using the push buttons and the LCD-display, it is possible to change settings of the set channel list channel without the need for an external terminal. The radio modem will enter to the channel list submenu by pressing the SETUP-push button (■). When activated the menu shows a listing of the changeable parameters.

With the help of the main menu, sub-menus can be selected which in turn can be used to change the settings. You can always return to the previous higher level of the menu structure by pressing the CANCEL (or BACK) push button (●). Pressing the ▲ or ▼ button changes settings or moves in the menu. Selections are confirmed by pressing the SELECT or SET button. In case of numerical values the digit to be changed is selected by pressing the NEXT button (see following page).

5.2.1 SATELLINE-4Pro LCD-display after power-up

The display shows the basic information.

Display in Data Transfer Mode (transmit/receive mode)

Ψ -120 █ 12.2V CH0 35W TX 430.000.000 MHz RX 430.000.000 MHz Spacing: 12.5kHz INFO SETUP	Ψ -120: Received signal strength of last received data or noise level (indicated with "Ψ") █ 12.2 = Supply voltage level indicator. CH0: in use channel number. 35W: set TX power. TX/RX: operational TX and RX frequency. Spacing: In use channel spacing Info and setup menus
---	--

INFO - SETUP

By pressing cancel/back button (●) the modem goes to detailed information about the modem's settings.

By pressing SETUP button (■) the modem enters the channel list submenu (requires defined channels in the channel list!).

Display in Info mode.

Pressing ▲ ▼ shows the next window.

INFO FIELD 1 Compatibility SATEL-8FSK-2 Repeater OFF FEC OFF Exit ▼	Compatibility mode Repeater mode Forward Error Correction Mode
---	--

INFO FIELD 2 Port1 115200bps/8N1 RX addresses RX1 OFF RX2 OFF Exit ▲ ▼	Serial port settings RX addresses and state
--	--

INFO FIELD 3 TX addresses TX1 OFF TX2 OFF S/N 1844 XXXX Exit ▲ ▼	TX addresses and state Device serial number
--	--

INFO FIELD 4 FW: 1.0.1.0 HW: SPL0046 Exit ▲	Device firmware version Device hardware version
---	--

Display in Setup Mode

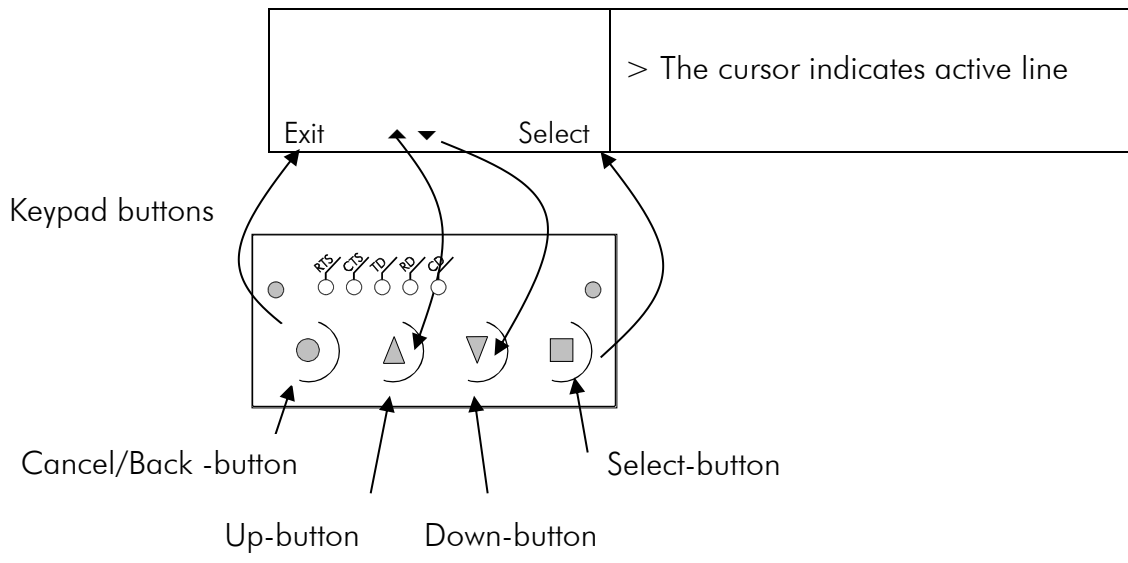

6 CONNECTION INTERFACES

NOTE!

When installing the cables of the serial interface, it is recommended that the operating voltage of all devices is powered OFF.

6.1 RS-232 interface

RS-232 standard defines the method of serial data transfer between a computer and its peripherals. The definition includes both the interface type and signal levels. Most computers and peripherals contain one or more RS-232 type serial ports. The RS-232 standard uses transmission lines, in which each single signal line level is referenced, to a common ground level. RS-232 has been designed to be use in serial transfer of data, in situations where the distance between communicating equipment is less than 15 m. The otherwise useful RS-232 standard is applied in a multitude of slightly differing ways, (e.g. different pin configurations) and for this reason different computers and peripherals are not necessarily directly compatible with each other.

6.2 Connectors

The device adopts a high standard waterproof ODU 8-pin data connector. Antenna connector type is 50 Ohm TNC female.

Data connector (8 pin ODU)

- DTE is an abbreviation for Data Terminal Equipment
- I/O column below denotes the direction of the signal
- "IN" is from DTE to the radio modem, "OUT" is from the radio modem to DTE

PIN	NAME	I/O	LEVEL	EXPLANATION
1	RTS	IN	RS-232	Request To Send from DTE
2	CTS	OUT	RS-232	Clear To Send. This signal indicates that the radio modem's serial interface is ready to receive data from DTE.
3	SGND	-	-	Signal ground
4	RD	OUT	RS-232	Receive Data to DTE from the radio modem
5	TD	IN	RS-232	Transmit Data from DTE to the radio modem
6	Not connected			
7	Not connected			
8	Not connected			

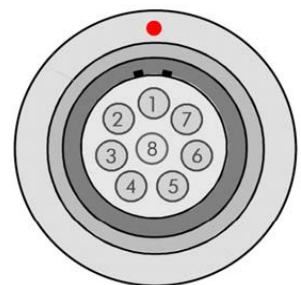

Power connector

(4 pin ODU MINI-SNAP Style G4 size 1)

PIN	NAME	EXPLANATION
1	PWR (+)	Operation Voltage +9 ... +16 VDC Note**
2	PWR (+)	Operation Voltage +9 ... +16 VDC Note**
3	GND	Ground Note***
4	GND	Ground Note***

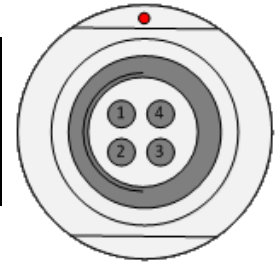

Note**) Both PWR pins 1&2 must be connected!

Note***) Both GND and pins 3&4 must be connected!

7 RF INTERFACE

The SATELLINE-4Pro has a single TNC type RF-connector with impedance of 50 Ohm. When the modem is supplied the frequency is set to "default channel". The user can change the frequency afterwards by 63.82 MHz. Of course, all local regulations set forth by the authorities must be taken into consideration.

The data speed of the radio interface is set to "default speed". It can also be set afterwards. A channel spacing of 25 kHz enables a data speed of up to 28800 bps and a channel spacing of 12.5 kHz enables, correspondingly, a data speed of up to 14400 bps. The data speed of the radio interface is always fixed depending on the modulation setting irrespective of the data speed of the serial interface. If the data speeds of the radio interface and the serial interface differ from each other, the radio modem will buffer the data in transfer temporarily, so no data loss will occur.

7.1 Transmitter

The output power of the transmitter is adjustable. The greatest allowable power depends on limits set by local authorities, which should not be exceeded under any circumstances. The output power of the transmitter should be set to the smallest possible level, which still ensures error free connections under variable conditions. Large output power levels using short connection distances can, in the worst case, cause disturbances to the overall operation of the system.

OUTPUT POWER	dBm
2 W	+33
10 W	+40
20 W	+43
25 W	+44
35 W	+45,4

Table:Typical output power levels.

NOTE!

Setting the radio data modem output power level to that which exceeds the regulations set forth by local authorities is strictly forbidden. The setting and/or using of non-approved power levels may lead to prosecution. SATEL and its distributors are not responsible for any illegal use of its radio equipment, and are not responsible in any way of any claims or penalties arising from the operation of its radio equipment in ways contradictory to local regulations and/or requirements and/or laws.

7.2 Receiver

The sensitivity of the receiver depends on the channel spacing of the radio modem (=data speed of the radio interface) and on the mode of the FEC (error correction) according to the table below (BER 10E-3):

	12.5 kHz	25 kHz
4FSK FEC OFF	-115 dBm	-112 dBm
4FSK FEC ON	-117 dBm	-116 dBm
8FSK FEC OFF	-107 dBm	-103 dBm
8FSK FEC ON	-115 dBm	-114 dBm
16FSK FEC ON	-108 dBm	-106 dBm

The Signal Threshold Level setting of the receiver determines a level, above which the search for the actual data transfer signal is active. It is recommended that values given in the table are used. If the Signal Threshold Level setting is set too low (the CD-LED is ON constantly), it is possible that the receiver is trying to synchronise itself with noise, in which case, the actual data transmission might remain unnoticed. Alternatively, weak data transmissions will be rejected, even though they would be otherwise acceptable.

7.3 Priority RX/TX

SATELLINE-4Pro offers a *Priority* setting, which selects the priority between reception and transmission. The setting can be changed via Configuration Manager PC-program. By default, transmission has higher priority than reception i.e. the default value is Priority TX.

Priority TX means that a terminal device attached to a radio modem decides the timing of the transmission. The transmitter is immediately switched on when the terminal device starts to output data. Should reception be in progress, the radio modem will stop it and change to a transmit state. There is no need to use any handshaking for the control of timing.

Priority RX means that a radio modem tries to receive all data currently in the air. If a terminal outputs data to be transmitted (or an SL command) it will be buffered. The radio modem will wait until the reception has stopped before transmitting the buffered data. This will result in timing slacks to the system, but decreases the number of collisions on the air; this is particularly useful in systems based on multiple random accesses.

If the Repeater Function has been set on, priority setting is automatically switched to RX mode.

7.4 Forward Error Correction

Forward Error Correction, FEC-function is switched ON (or OFF) by using the Configuration Manager PC-program (or via LCD UI when channel list defined). When activated, the FEC-function will cause the SATELLINE-4Pro to automatically add additional error correction information, which increases the amount of transmitted data by 30 %. It is used by the receiving radio modem to correct erroneous bits - as long as the ratio of correct and erroneous bits is reasonable.

Error correction improves the reliability of data transfer via the radio interface especially in unfavourable conditions. FEC-function should be used when link distances are long and/or if there are many disturbances in the radio channels used. The use of the FEC-function will, however decrease the data transfer throughput of data by about 30 %. The list of exact delays when using FEC-function, are introduced in appendix B.

NOTE!

All radio modems, which are to communicate with each other, must have the same setting for FEC (ON or OFF). If the transmitting radio modem and the receiving radio modem has different settings, data will not be received correctly.

7.5 Error checking

When the error checking is switched on, the radio modem will add a checksum to the transmitted data. When the data is received, the checksums are verified before data is forwarded to the serial port.

Error check checks data partially while data is received.

Full CRC16 check function adds two checksum characters at the end of the user data message. At the reception end the receiver receives first the whole package and if the checksum matches the data message is forwarded to the serial port. If *Full CRC16 check* is selected it must be set ON for all radio modems in the same network. Otherwise the checksum characters appear at the end of user message on the serial port.

7.6 Dual radio function, separate RX/TX-frequencies

The SATELLINE-4Pro can transmit (TX-frequency) and receive (RX-frequency) on separate frequencies. Separate frequencies can be set within the whole tuning range. The frequencies can be set with the Configuration Manager PC-program.

When data flow on the TD line starts the frequency shifts from the receiving channel to the transmit channel. There is a 40 ms delay caused by the frequency shift before the actual data transmission sequence starts, and the same time is needed for the return to the receive channel after transmission.

The selected channel spacing, port settings etc. are equal to both frequencies.

The dual radio settings can be adjusted also by the SL commands.

7.7 User data whitening

In some cases, if the user data includes a large number of constant characters, additional bit errors may appear. The use of error correction (FEC) is recommended in such cases. If that is not possible, the Data whitening feature can be used to improve the reliability of data transfer.

NOTE!

All radio modems, which are to communicate with each other, must have the same setting for Data whitening (ON or OFF). If the transmitting radio modem and the receiving radio modem has different settings, data will not be received correctly.

7.8 Pacific Crest, TRIMTALK and SOUTH compatibility

7.8.1 General

SATELLINE-4Pro radio modem supports additional to the original SATEL 3AS data transfer also:

- Pacific Crest compatible data transfer over the air, if the opponent Pacific Crest modems operate in the transparent mode/FEC ON/Scrambling ON that is the most common setup among RTK applications. The other modes are currently not supported.
- TRIMTALK® 450s compatible data transfer over the air.
- SOUTH GDL radios (trademark of SOUTH Surveying & Mapping Instrument Co., Ltd).
 - Pacific Crest XDL/ADL radios in the SOUTH radio compatible mode
 - Only 25 kHz channel width on 400 MHz frequency band is supported.

SATELLINE-4Pro radio modem provides the following radio compatibility settings:

- Pacific Crest 4-FSK modulation, Transparent mode/FEC ON/Scrambling ON.
- Pacific Crest GMSK modulation, Transparent mode/FEC ON/Scrambling ON.
- TRIMTALK GMSK modulation, Transparent mode
- TrimTalk450s(T) = TrimTalk450s GMSK (Rx fitted to Trimble transmitter)
- Pacific Crest-FST = Pacific Crest Transparent FST (4-FSK), FEC ON/Scrambling ON.
- SOUTH (SOUTH Surveying & Mapping Instrument Co. Ltd)

So far, only the transparent mode is implemented, since it is the most commonly used and recommended by the user manuals. The ARQ based protocols with ACK/NACK schemes are not preferred in RTK applications that apply one-way communication.

The implementation of Options 1, 2, 3 is based on the reference measurements and the available public data of the following radio modems manufactured by Pacific Crest Corporation: RFM96W, PDL HPB, PDL LPB. TRIMTALK is a trademark of Trimble Navigation Ltd.

7.8.2 Configuration by using SL commands

"SL@S=" command selects the compatibility mode:

- "SL@S=0" sets SATELLINE-3AS (default).
- "SL@S=1" sets PCC-4FSK
- "SL@S=2" sets PCC-GMSK
- "SL@S=3" sets TRIMTALK GMSK, RX fitted to Pacific Crest transmitters
- "SL@S=4" sets TRIMTALK GMSK, RX fitted to Trimble transmitters
- "SL@S=5" sets PCC-FST
- "SL@S=8" sets SOUTH

The modem responds with "OK" message if the requested mode is supported or "ERROR" if the mode is not allowed.

"SL@S? enquires the active mode. The modem responds with a number:

- "0" if the mode is SATEL 3AS
- "1" if the mode is PCC-4FSK
- "2" if the mode is PCC-GMSK
- "3" if the mode is TRIMTALK GMSK, RX fitted to Pacific Crest transmitters
- "4" if the mode is TRIMTALK GMSK, RX fitted to Trimble transmitters
- "5" if the mode is PCC-FST
- "8" if the mode is SOUTH

7.8.3 Settings

In order to use the Pacific Crest/TRIMTALK modes implemented in SATELLINE modems:

PACIFIC CREST modems must have:

- Protocol Mode =
 - Transparent w/EOT Timeout (when using Pacific Crest modulations)
 - TrimTalk 450s (when using TRIMTALK GMSK modulation)
 - Transparent FST
- Modulation Type depends on the system
 - GMSK (default, always selected when using TRIMTALK 450s mode)
 - 4-Level-FSK
- FEC = ON (FEC OFF state supported in PCC Transparent FST protocol implementation)
- Scrambling = ON
- Data Security Code set to = 0 (=not used)
- Local Address= 0...254 (0 by default)
Pacific Crest modem receives messages from SATELLINE modems that have their TX1 address matching the Local Address.
- Remote address=0...255 (255 by default, that is the broadcast address to be received by all). SATELLINE modems receive the message from a Pacific Crest modem, provided their

RX1 address matches the Remote Address of a Pacific Crest transmitter (or if the message has the broadcast address 255).

SATELLINE modems must have the following key settings:

- FEC OFF (because the FEC here means SATEL 3AS FEC, not Pacific Crest/TRIMTALK FEC)
 - Error check OFF
 - Full CRC16 check OFF
 - Radio Compatibility (according to selected Pacific Crest protocol mode setting)
 - Pacific Crest 4-FSK
 - Pacific Crest GMSK
 - TRIMTALK GMSK, RX fitted to Pacific Crest transmitters
 - TRIMTALK GMSK, RX fitted to Trimble transmitters
 - PCC-FST
 - Addressing:
 - When TX address is selected ON, then TX1 address is used like PDL Remote address that is the destination address for the transmitted messages.
Default value is 0x00FF (=255) (note the hexadecimal format of the setting)
 - When RX Address is selected ON, then RX1 address is used like PDL Local address
Default value is 0x0000 (=0) (note the hexadecimal format of the setting)
- Note: Addresses are NOT applicable in TRIMTALK 450s mode so SATELLINE modems must have their RX/TX addresses OFF with Option3.

The configuration tools and settings are different between SATELLINE and Pacific Crest modems:

- Pacific Crest modems are configured via the serial port using PDLCONF Windows™ program that sends binary control messages to the serial port of the modem.
- SATELLINE-4Pro radio modems are configured via the serial port using SATEL Configuration Manager PC-program.

The table below shows the analogy of settings between Pacific Crest and SATELLINE radio modems (status in firmware version v3. 46.3).

Pacific Crest setting	Corresponding SATELLINE-4Pro setting
Identification: Owner	(not implemented)
Identification: Channel Bandwidth	Channel spacing
Identification: RF Power	TX power
Radio Link: Channel Selection Type (Manual)	Radio frequency
Radio Link: Current Channel	Radio frequency
Radio Link: Link Rate	The fixed link rates are: Option 2 & 3: 9600bps@25kHz / 4800bps@12.5kHz Option 1: 19200bps@12.5kHz / 9600bps@12.5kHz
Radio Link:Modulation Mode	Compatibility->PCC-4FSK Compatibility->PCC-GMSK Compatibility->TRIMTALK GMSK
Radio Link:Scrambling	ON by default

Radio Link:Transmit Retries	(not implemented)
Radio Link:TX ACK Timeout	(not implemented)
Radio Link:Csma Monitoring	Priority (RX=ON, TX=OFF) Default: RX
Radio Link: AutoBase/AutoRover	(not implemented)
Radio Link:Digisquelch	Signal threshold
Radio Link:Forward Error Correction	ON by default using Option 1, 2, 3 (Note: SATELLINE-4Pro FEC must be OFF!)
Radio Link:Local Address (0 by default)	Primary RX address (RX1) (OFF by default)
Radio Link:Remote Address (255 by default)	Primary TX address (TX1) (OFF by default)
Serial Interface:Protocol Mode	Radio compatibility: Options 1 and 2 = Transparent w/EOT Timeout Option 3 = TRIMTALK 450s, RX fitted to PCC Option 4 = TRIMTALK 450s, RX fitted to Trimble Option 5 = PCC Transparent FST
Serial Interface:BREAK to Command	(not implemented)
Serial Interface:Modem Enable: Yes	(not applicable)
Serial Interface:Soft Break Enable	(not implemented)
Serial Interface:EOT value (in 0.01s units)	Pause length (in serial port byte intervals)
Serial Interface:Digipeater Delay(in0.01s units)	(not implemented)
Serial Interface:Local Node Repeater	(not implemented)
Frequency Table	Radio frequency
Data Security Code (must be 0=not used)	(not implemented)
<p>Potential conflicts:</p> <ul style="list-style-type: none"> - Pacific Crest Local/Remote addresses are supported in the firmware versions starting from v3. 46.3 - Repeater function is supported only in the firmware versions starting from v3. 46.3 - Error check and Full CRC16 check must be OFF in SATELLINE modem - FCS (Free Channel Scanning) feature is not supported by Pacific Crest radios - Message Routing is not supported by Pacific Crest radios - SATELLINE RX/TX addressing does not use ARQ scheme like Pacific Crest radios. - Pac Crest Transparent FST protocol supported starting from firmware version 3.57 	

7.8.4 Repeater function

The implemented Pacific Crest/TRIMTALK modes support also the repeater function. The repeater function is configured either by using the SL commands:

- "SL@M=R" (Repeater ON)
- "SL@M=O" (Repeater OFF)

Note 1. The repeater modem passes TRIMTALK messages also to its serial port unlike for example Pacific Crest PDL modems.

Note 2. If error correction is ON (FEC ON) and TRIMTALK mode is activated by using "SL@S=3" command, the firmware automatically switches SATEL FEC OFF temporarily, and turns it back at the mode return.

7.8.5 Support for Local / Remote addresses

If the modem has TX address ON then primary TX address is handled in the same way as Remote address in Pacific Crest PDL modems. The default value is 0x00FF (255 in decimal format) i.e. the broadcast address.

If the modem has RX address ON then primary RX address is handled in the same way as PDL Local address in Pacific Crest PDL modems. The default value is 0x0000 (0 in decimal format). SATELLINE modem needs to have TX Delay 50ms or more in order to avoid messages from colliding in case it is to be placed in a Pacific Crest system that uses addressing and acknowledging scheme.

Note 1. SATELLINE-modems do not support Pacific Crest retransmit/acknowledge scheme. However, that has no effect in RTK applications because they utilize only broadcast messages.

7.8.6 Latency

In the PCC Transparent protocol mode (Option 1 and Option 2) the whole message is first read from the serial port and after that it will be framed and transmitted over the radio.

The end of the message is detected when there is a pause in data coming from the serial port.

The symbol rates for the Pacific Crest 4FSK (Option1) are:

- 19200 bps on 25 kHz channel
- 9600 bps on 12.5 kHz channel

The symbol rates for the Pacific Crest GMSK (Option2) are:

- 9600 bps on 25 kHz channel
- 4800 bps on 12.5 kHz channel

The actual raw data rate is appr. 2/3 of the symbol rate.

7.8.6.1 Transmission delays using Pacific Crest 4FSK on 25 kHz channel

The table below presents the typical latency vs. the size of the message. The delays are measured from the end of transmitted data to the end of received data on the serial interface.

Number of bytes sent				
Bps	1	10	100	500
1200	77 ms	159 ms	971 ms	4590 ms
4800	48 ms	68 ms	317 ms	1438 ms
9600	43 ms	52 ms	209 ms	912 ms
19200	40 ms	45 ms	154 ms	650 ms
38400	39 ms	41 ms	127 ms	519 ms

7.8.6.2 Transmission delays using Pacific Crest GMSK on 25 kHz channel

The table below presents the typical latency vs. the size of the message. The delays are measured from the end of transmitted data to the end of received data on the serial interface.

Number of bytes sent				
Bps	1	10	100	500
1200	86 ms	168 ms	1042 ms	4949 ms
4800	57 ms	77 ms	390 ms	1796 ms
9600	52 ms	62 ms	281 ms	1272 ms
19200	50 ms	55 ms	226 ms	1009 ms
38400	48 ms	51 ms	198 ms	878 ms

8 TRANSPARENT DATA TRANSMISSION

8.1 Serial interface, data format

The SATELLINE-4Pro serial interface uses an asynchronous data format. No external synchronising signal is needed, since necessary timing information is acquired from the start and stop bits transmitted before and after each data field bits (byte).

The data transfer speed of the serial interfaces can be set to 9600, 19200, 38400, 57600 or 115200 bps (bits per second). The length of the data field must 8 bits. A parity bit may also be used.

Example: With an 8-bit data character length and taking, for example, a decimal value of "204", (which corresponds to a binary value of "11001100") and with a start bit value of "0", parity bit set to either "NO" (NONE), "0" or "1" and with a stop bit value of "1", the possible combinations are listed in the table below:

If the settings of data speed, character length, parity or the number of stop bits differ between the radio modem and the terminal, errors will be introduced into the transferred data. The serial port settings of each individual radio modem in a system can all be different apart from the data length setting, which must always be the same in each individual radio data modem. In other words, the serial port used, the data transfer speed, parity and number of stop bits; can be different in different parts of a same system. This is especially useful where one part of the system uses an RS-485 serial port and another part uses the RS-232 serial port. In other words, radio modems may also be utilised as serial port converters in addition to the more common role of wireless data transfer.

Serial interface settings of the modem and terminal device connected to it must match.

8.2 Handshake lines

When using the RS-232 serial interface, handshake signals can be used to control data transfer. Handshake signals are used, for example, by the radio modem to inform the terminal that the radio channel is busy, and that it cannot initiate transmission. The terminal can also control the radio modem via RTS-line.

Line	Direction
CTS	To terminal
RTS	To modem
CD	To terminal

A common way of using handshaking signals is to monitor the CTS-line and ignore the others. Usually the terminal is fast enough to handle the data received by the radio modem, so the use of RTS-line is not necessary.

Handshaking is not needed if the system protocol is designed to prevent collisions (data contention) by the use of polling, or if there is little traffic and also if there is no harm from occasional data contention situations (several radio modems try to transmit at the same time).

8.2.1 CTS-line

The options for CTS-line are:

1) Clear To Send

CTS is active when the radio modem is ready to accept data for new transmission. CTS will shift into inactive state during data reception and transmission.

2) TX buffer state

CTS will shift into inactive state only if the radio modem's TX buffer is in danger of overflowing. This typically happens when the serial interface data transfer speed is greater than the radio interface transfer speed and the size of transmitted messages is large.

8.2.2 RTS-line

The options for RTS-line are:

1) Ignored

RTS-line status is ignored.

2) Flow control

The radio modem transmits data to the terminal device only when the RTS-line is active. Non-active state of the RTS-line will force the radio modem to buffer the received data. This option is used if the terminal device is too slow to handle data received from the radio modem.

3) Reception control

RTS-line controls the reception process of the radio modem. An active RTS-line enables reception (as normal). Non-active RTS-line will interrupt reception process immediately, even if the radio modem is receiving a data packet. This option is used to force the radio modem into WAIT State for an immediate channel change.

8.3 Timing and delays during data transmission

When using a radio modem for data transmission, certain delays will be formed through the use of a radio interface and from the radio modem circuitry itself. These delays exist when the radio modem switches from *Standby Mode* to *Data Transfer Mode* and during reception and transmission of data. For detailed delay values in each case see Appendix B.

8.3.1 Data buffering in the radio data modem

Whenever the radio modem is in *Data Transfer Mode* it monitors both the radio channel and the serial interface. When the terminal device starts data transmission the radio modem switches to transmission mode. At the beginning of each transmission a synchronisation signal is transmitted and this signal is detected by another radio modem, which then switches into receive mode. During the transmission of the synchronisation signal the radio modem buffers data into its memory. Transmission ends when a pause is detected in the data sent by the terminal device, and after all buffered data has been transmitted. When the serial interface speed is the same or slower than the speed of the radio interface, the internal transmit buffer memory cannot overflow. However, when the serial interface speed exceeds the speed of the radio interface, data will eventually fill transmit buffer memory. In this instance, it will take a moment after the terminal device has stopped transmission of data for the radio modem to empty the buffer and before the transmitter switches off. The maximum size of transmit buffer memory is one kilobyte (1 kB). If the terminal device does not follow the status of the CTS-line and transmits too much data to the radio modem, the buffer will be emptied and the transmission is restarted.

In the receive mode, the buffer works principally in the above described way thus evening out differences in data transfer speeds. If the terminal device transmits data to a radio modem in receive mode, the data will go into transmit buffer memory. Transmission will start immediately when the radio channel is available.

8.3.2 Pause length

The modem recognises a pause on the serial line (a pause is defined as a time with no status changes on the RS-232 interface TD-line). The pause detection is used as criteria for:

- End of radio transmission - When the transmit buffer is empty and a pause is detected, the modem stops the transmission and will then change the radio to the receive mode.
- SL-command recognition - For a SL-command to be valid, a pause must be detected before the actual "SL..." character string.
- User address recognition - In order for the start character to be detected, a pause must precede it in transmission.

Traditionally, in asynchronous data communication, pauses have been used to separate serial messages from each other. However, the use of non-real-time operating systems (frequently used on PC-type hardware) often adds random pauses, which may result in the user data splitting into two or more separate RF transmissions. This may cause problems especially in the systems including repeater stations.

In order to match the operation of the radio modem to the user data, the Pause length parameter can be adjusted via SATEL Configuration Manager PC-program. It may have any value between 3 and 255 characters. The default value is 3 characters.

Notes:

- The absolute time of Pause length is depending on the serial port settings. For example, 1 character is ~1.04 ms at 9600 bps / 8N1 (10 bits).

- The maximum absolute time is always 170 ms independent from the value of the Pause length given in the set-up.
- An increase in the Pause length increases the round trip delay of the radio link correspondingly; this is due to the fact that the radio channel is occupied for the time of the Pause length after each transmission (the time it takes to detect a pause). If this is not acceptable, the TX delay setting may also be useful in special cases.

8.3.3 TX delay

The radio modem can be configured to delay the beginning of a radio transmission by 1...65000ms. This function can be used to prevent packet contention in a system, where all substations would otherwise answer a poll of a base-station simultaneously. During this delay data sent to the radio modem is buffered. Although the priority setting is "RX", radio modem is prevented to change over to receiving mode during the period of the TX delay. If this function is not needed, the delay time should be set to 0 ms.

8.4 Testing

The radio modem can be switched to the *Test Mode*, where it will send a test packet on the radio channel. The test packet is a normal data transmission, which can be used, for example, when directing antennas during system installation.

If the channel spacing of the radio modems is 25 kHz, it is recommended to use 38400 bps as a serial data speed of the receiving radio modem. In the case of 12.5 kHz channel spacing the data speed of 19200 bps is recommended.

There are two *Test Modes*:

Short data block test

In this test mode the radio modem sends a short test string, which is preceded by a consecutive number, and it ends to the line feed character. The short data block is repeated continuously after 1 s break.

Short data block test is suitable for running data communication tests. Error-free reception of data can be monitored using a suitable terminal program.

Example of a short data blocks:

```
00 This is a testline of SATELLINE-3AS radio modem
```

Long data block test

Long data block consists of character strings, which are repeated without breaks 50 s time period. After 10 s break the test transmission is started again.

Long block data test can be used for measuring Tx output power, standing wave ratio (SWR) of the antenna system or received signal strength at Rx stations. Using Long Block Test requires running the modem in radio compatibility mode SATELLINE-3AS.

Example of a long data blocks:

00 This is a long testline of SATELLINE-3AS radio modem

The strength of the received signal can be monitored using the LCD-display of the receiving radio modem.

NOTE 1! Red CD led (continuous) indicates active test mode.

NOTE 2! Normal data transfer is not available while the Test mode is active. Remember to switch it OFF before starting the normal data transfer.

NOTE 3! FCS mode must be disabled prior to set ON the Test mode.

9 SETTINGS

SATELLINE-4Pro contains push buttons and a LCD-display, which can be used to modify the pre-defined channel lists, created with SATEL Configuration Manager PC-program. Setting the channel list into use with channel list information is required before the device can be used. Additional information regarding the Configuration Manager can be found from the SW user manual. When radio connected to the Configuration Manager PC-program the radio modem will switch into Programming Mode, under which the radio is not capable of transmitting or receiving system data.

This is the display in *factory default settings*. Channel list is empty, thus displayed as ----- (no radio activity with default settings).

Displayed on LCD: TX power (35W), TX and RX frequencies, channel spacing (12.5 kHz).

Signal strength info is displayed on the upper left-hand corner:

- Current noise level value n-127 (here -127 dBm) or
- Last received signal strength indication, e.g. ¥ -98 (dBm). This measurement will be displayed ~7 seconds after last received data, after which the radio will start to measure noise level.

Input voltage level respectively on the upper right corner.

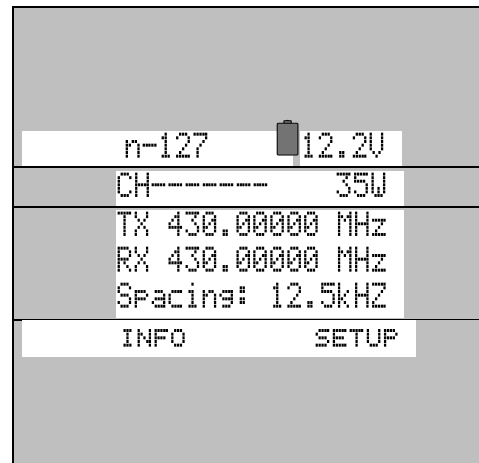

9.1 Changing the in use channel using the LCD-display

SATELLINE-4Pro contains an LCD -display that shows the valid functions and allows modification of the settings. After the Channel list is defined into the device with SATEL Configuration Manager PC-program, user can select the settings via LCD user interface according to channel list limitations.

On standby mode the LCD-display will display the basic information. The following settings are shown: In use channel, TX power, TX and RX frequencies and Channel Spacing. Additional information is available under INFO tab. More information about the info menu can be found from this user manuals section 5.2.1.

The main menu is used to select the desired submenus, and the modifications are performed using these submenus. It is possible to jump back at any time to the previous (higher) level in the menu hierarchy by just pressing the "CANCEL"-button (or in some cases the "EXIT"-button). Pressing the ▲ or ▼ button modifies parameters with numerical values consisting of digits. Use until the said digit (with the cursor blinking under it) has reached the desired value. In the case of numerical values the "NEXT-button is used to move on to the next digit in the numerical value and then the above described process is used to modify it. The process is repeated until all digits in the value have been edited. Toggle-type parameters (typically with ON/OFF choices modifications have to be confirmed by pressing the "SELECT"- or "SET"-button.

After pressing the "SET-UP-button the display will show the main menu, which is a list of modifiable parameters. Pressing the ▲▼ buttons the cursor moves upwards and downwards. When the cursor > is placed beside the desired selection, entry into sub-menu is done by pressing the SELECT-button.

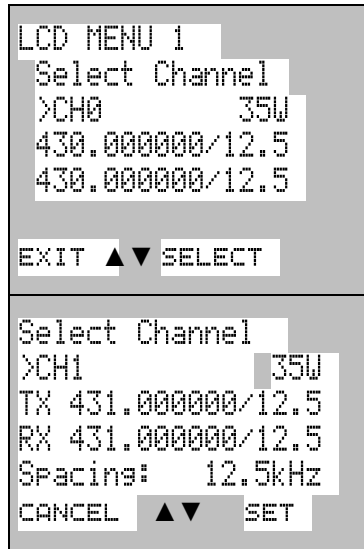

If more than one channel is defined to the radio, user can select. Pressing SELECT -button the set channels can be viewed by pressing the ▲▼ buttons.

9.1.1 Viewing the set Channel List -settings

After pressing the SETUP -button the display will show the main menu, which is a list of set channels.

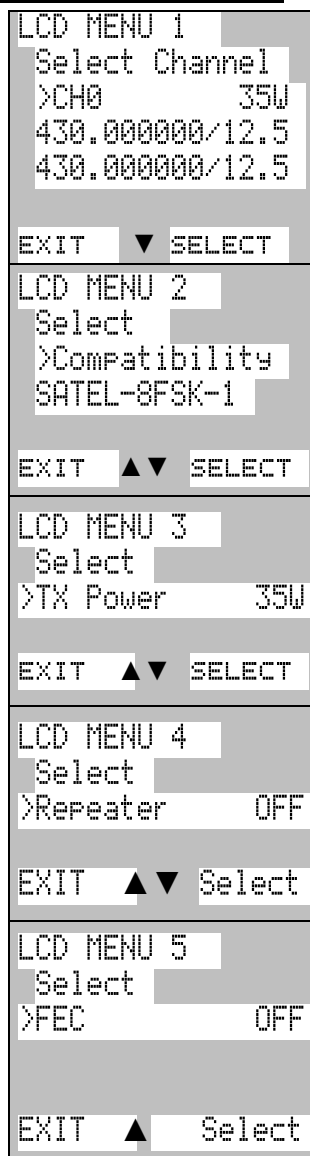

Pressing the ▲▼ buttons the channel settings can be viewed and modified.

9.1.1 LCD UI Info

After pressing the INFO -button the display will show the current, in use channel settings.

```
INFO FIELD 1
Compatibility
SATEL-8FSK-1
Repeater      OFF
FEC           OFF
EXIT          ▼
```

Pressing the ▲▼ buttons the device info can be viewed.

```
INFO FIELD 2
Port1 115200/8N1
RX addresses
RX1 OFF
RX2 OFF
EXIT        ▲▼
```



```
INFO FIELD 3
TX addresses
TX1 OFF
TX2 OFF
S/N 1844 XXXXX
EXIT        ▲▼
```



```
INFO FIELD 3
TX addresses
TX1 OFF
TX2 OFF
S/N 1844 XXXXX
EXIT        ▲
```



```
INFO FIELD 4
FU: 1.0.1.0
HU: SPL0046
EXIT        ▲
```



9.1.2 Saving modified values into the internal memory

After all desired modifications have been performed; they have to be saved in order to make them permanent (until next modification). This is accomplished by choosing selection "EXIT" from the main menu. The display will then show a message (see below) asking a confirmation of the performed modifications.

By choosing "YES" all modifications are saved into the non-volatile memory inside the radio modem. By choosing "NO" all modification performed are cancelled and previous settings remaining in the non-volatile memory.

Press "YES" to save all modifications into the non-volatile memory and "NO", if modifications are to be cancelled.

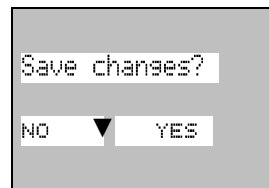

9.2 Changing parameters using the SL-commands

The controlling terminal device can change the configuration settings of a radio modem. This is accomplished with the help of SL-commands, which can be used in data transfer mode. SL-commands can be used to change e.g. the frequency or addresses. It is also possible to interrogate a radio modem in order to gain information concerning current settings that are in use. The terminal device is either a PC or a programmable logic (PLC) together with suitable (terminal) program. SL-commands must be enabled using SATEL Configuration Manager PC - program before they can be used.

An SL-command is a continuous string of characters, which is separated from other data by pauses that are equal or greater than time defined by Pause length parameter in the set-up. No extra characters are allowed at the end of an SL-command. Serial interface settings are the same as in data transfer and MODE pin of the serial connector **MUST NOT** be connected to ground (GND). SL-command is properly recognised also in the case when the command string is terminated in <CR> (=ASCII character no. 13, Carriage Return, 0x0d) or <CR><LF> (<LF> = ASCII char. no. 10, Line Feed, 0x0a). If multiple SL commands are sent to the radio modem the next command can be given after receiving the response ("Ok" or "Error") of the proceeding command. In addition, it is recommended to implement a timeout to the terminal software for recovering the case when no response is received from the radio modem.

When the power of a radio modem is switched off the configuration settings of a radio modem always return to values defined initially using the SATEL Configuration Manager PC-program, thus resetting any settings changed using SL-commands during power on. It is however possible to save settings changed by using SL-commands and to make them the new configuration settings.

The radio modem will acknowledge all commands by returning an "OK" (command carried out or accepted) or the requested value, or an "ERROR" (command not carried out or interpreted as erroneous) message.

In case you need more information on the time delays related to the use of SL-commands, please contact the manufacturer.

In order to get information of the latest and/or special SL-commands please contact SATEL Oy.

9.2.1 Frequency

Command	Effect and description of command
SL&FR=nnn.nnnnn	Set RX-frequency to nnn.nnnnn MHz
SL&FT=nnn.nnnnn	Set TX-frequency to nnn.nnnnn MHz
SL&F=nnn.nnnnn	Set both RX&TX-frequency to same nnn.nnnnn MHz
SL&FR?	Get RX- frequency (response 'nnn.nnnnn MHz')
SL&FT?	Get TX- frequency (response 'nnn.nnnnn MHz')
SL&F?	Get RX&TX- frequencies (response TX nnn.nnnnn MHz, RX nnn.nnnnn MHz)
SL&C?	Get Reference (Center) frequency (response 'nnn.nnnnn MHz')
SL&C=nnn.nnnnn	Set Reference (Center) frequency to nnn.nnnnn MHz
SL&+=nn	Set RX&TX- frequency nn channels above reference frequency Frequency = Reference frequency + nn * Channel spacing, where nn=[0...Number of channels/2]
SL&-=nn	Set RX&TX- frequency nn channels below reference frequency Frequency = Reference frequency – nn * Channel spacing, where nn=[0...Number of channels/2]
SL&N?	Get current RX&TX- frequency deviation from reference frequency as channels (Frequency – Center frequency)/Channel spacing (response '+nn' or '-nn')
SL&W?	Get channel spacing (response 'nn.n kHz')
SL&D?	Get operational mode of the radio. The response is one of the following: "S" = Single Channel "D" = Dual Channel "R" = Reverse Dual Channel Note! Use this command only, if the setup of the frequency bands matches the Dual Channel operation.

9.2.2 Addressing

xxxx = address in hexadecimal format (0000 ... FFFF)

Command	Effect and description of command
SL#I=xxxx	Set all addresses (RX1, RX2, TX1, TX2) to value xxxx
SL#I?	Get both primary addresses (TX1, RX1) (response 'xxxx;yyyy')
SL#T=xxxx	Set both transmit addresses (TX1, TX2) to value xxxx
SL#T?	Get primary transmit address (TX1) (response 'xxxx')
SL#R=xxxx	Set both receive addresses (RX1, RX2) to value xxxx
SL#R?	Get primary receive address (RX1) (response 'xxxx')
SL#Q=x	Set TX address on x=1, off x=0
SL#Q?	Get status of the TX address (response '1' on, response '0' off)
SL#W=x	Set RX address on x=1, off x=0
SL#W?	Get status of the RX address (response '1' on, response '0' off)
SL#P=xxxx;yyyy	Set primary transmit address (TX1) to value xxxx and receive address (RX1) to value yyyy
SL#S=xxxx;yyyy	Set secondary transmit address (TX2) to value xxxx and receive address (RX2) to value yyyy
SL#P?	Get primary transmit address (TX1) and receive address (RX1) (response 'xxxx;yyyy')
SL#S?	Get secondary transmit address (TX2) and receive address (RX2) (response 'xxxx;yyyy')
SL#A=xxxx,yyyy,wwww,zzzz	Set addresses to values TX1=xxxx TX2=yyyy RX1=wwww RX2=zzzz
SL#A?	Get all addresses (response 'xxxx, yyyy, wwwww, zzzz')

9.2.3 Radio parameters

Command	Effect and description of command
SL@R?	Get field strength of the last received message (the value is an average of many measurements made during the same reception). Response "-xx dBm", where xx is a decimal value of the field strength and it is between -80 dBm and -118 dBm. Value available 7s after reception.
SL@P=xxxxx	Set RF output power, where xxxxx is the decimal value of the intended power in mW. If the given value does not correspond to one of the programmed power levels, the output power is set to the nearest possible value.
SL@P?	Get RF output power. Response "xxxxx mW", where xxxxx is a decimal value the output power of the transmitter.
SL@T=-xxx	Set minimum power level of the signal to be received (= "Signal Threshold level"), where xxx is a decimal value of the new intended level in dBm.
SL@T?	Get current "Signal Threshold Level". Response is "-xxx dBm".
SL@D=x	Set TX delay. Value x = 0...65535 ms
SL@D?	Get TX delay value. Response 'x ms'
SL@F?	Get current noise level on the radio channel. Response "-xxx dBm".

9.2.4 Other functions

Command	Effect and description of command
SL**>	Set current settings as permanent settings. This command must be used only seldom and under controlled conditions in order to avoid the corruption of the settings, which may happen in case the power supply fails in the middle of the memory save procedure.
SL%V?	Get Firmware revision information (response 'Vn.nn')
SL%D?	Get modem type
SL%S?	Get modem serial number (response 'nnnnnnnnn' or 'No Serial nr')
SL%C?	Get specified information field. If not specified the response is 'No version id'. For more information please contact SATEL Oy.
SL%B?	Get serial data parameters, response is a,b,c,d where a= "115200", "57600", "38400", "19200", "9600" (defines the baud rate) b= "8" (defines the character length) c= "N", "E" or "O" (defines the parity) d= "1" or "2" (defines the number of stop bits)
SL%B=a,b,c,d	Set serial data parameters for data ports, where a= "115200", "57600", "38400", "19200", "9600" (defines the baud rate) b= "8" (defines the character length) c= "N", "E" or "O" (defines the parity) d= "1" or "2" (defines the number of stop bits) Response is "OK" at the original baud rate.

10 REPEATER MODE AND ADDRESSING

Repeaters and addressing may be used to extend the coverage area of a radio modem network, and to direct messages to selected radio modems in the network. In large systems, with several repeaters and formed repeater chains, it is often practical to use routing instead of plain addresses.

10.1 Repeater

In circumstances where it is necessary to extend the coverage area of a radio modem network, SATELLINE-4Pro can be used as repeater stations.

The maximum size of a repeated data packet is 1 kB (kilobyte). The *Repeater Function* is switched on using the SATEL Configuration Manager PC-program or via the LCD UI (when channel list defined to the device via SATEL Configuration Manager PC-program). In the repeater mode the radio modem will function as a totally independent unit, which means that only a power supply and a suitable antenna are needed. Other devices are not necessary.

A radio modem acting as a repeater can also be used to receive and transmit data. In repeater mode the radio modem will transmit the received data to the serial interface in a normal fashion. The difference being that the received data will be buffered into the buffer memory. After reception the radio modem will re-transmit the buffered data using the same radio channel as in reception. Data received through the serial interface a radio modem in repeater mode will transmit normally.

The same network may include several repeaters, which operate under the same base station. Repeaters may also be chained; in which case a message is transmitted through several repeaters. In systems with more than one serially or parallelly chained repeater, addressing or routing protocol must be used to prevent a message ending up in a loop formed by repeaters, and to ensure that the message finally reaches only the intended radio modem.

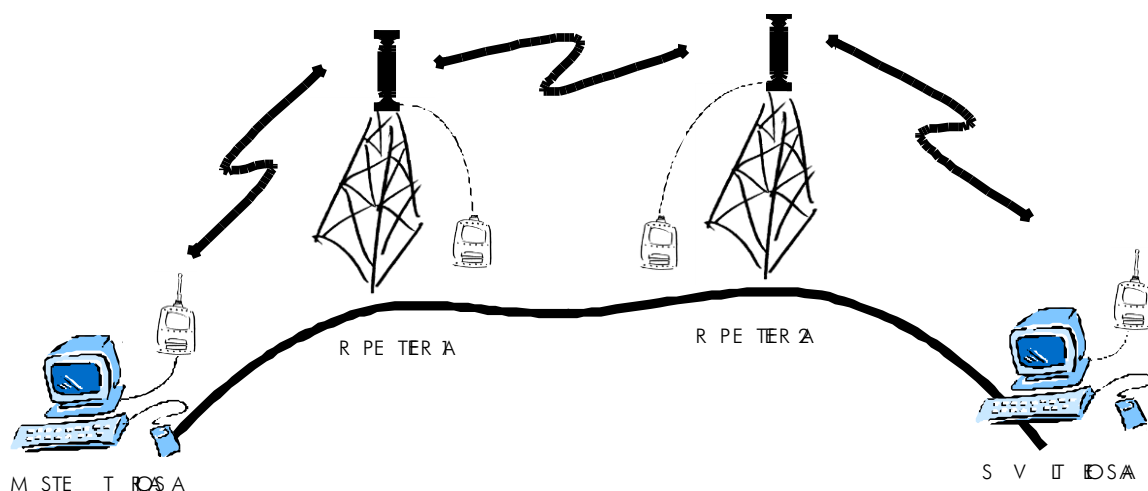

10.2 Addressing

Addresses can be used to route a data message to the desired destination or to separate two parallel networks from each other. In networks with repeaters it is usually necessary to use addresses to prevent data messages from ending up in loops formed by repeaters. In case of setting the "Message Routing" function in use, Tx / Rx addresses are ignored by the modem.

SATELLINE-4Pro allows the use of individual addresses both for reception and transmission. Addresses can be switched on separately, or simultaneously, in both data transfer directions.

The radio modem contains two transmission and two reception addresses, which are known as the primary address and secondary address. The primary address is used whenever data from the serial interface is transmitted. At the receiving end, the radio modem will receive using either of the two receive addresses.

Secondary transmit address is only used in repeater applications.

Radio modems configured to function as repeaters, will repeat data messages using either the primary or secondary address, depending upon which address was used during the reception of the data message.

If only one address pair is needed in a network, both addresses must be set the same (TX1 = TX2 and RX1 = RX2).

It is also possible to transfer the received address onto the serial interface.

The address is composed of two characters totalling 16 bits, resulting in over 65,000 different address combinations. The address is attached to the beginning of each data packet sent by the radio modem. When a radio modem receives a data packet whilst using addressing mode, the radio modem will check the first two characters of each received data packet to ensure that the packet in question was intended for the correct radio modem.

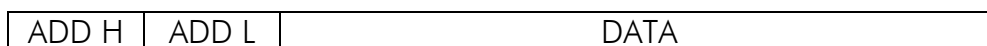

Address may be selected between 0000h...FFFFh (h = hexadecimal, corresponding decimal numbers are 0-65535).

Example: address 1234h (4660 in decimal format), where 12h is ADD H and 34h is ADD L.

Example: address ABFFh (44031 in decimal format), where ABh is ADD H and FFh is ADD L.

Transmission:



Transmission address has been set OFF. Radio modem will transmit the data packet as such.



Transmission addressing has been set ON. The radio modem will add the primary TX address to the beginning of the data packet.

Reception:



Reception addressing has been set ON and either the primary or secondary RX address of the radio modem is identical to the address of the received data packet.

The radio modem will remove the address and send the actual data to the RS-232 interface.

However, if the "RX Address to RD-line" setting is on, the radio modem does not remove the address.



Reception addressing has been set ON, but both the primary and secondary RX addresses of the radio modem are different from the address of the received data packet.

Data does not appear on the RS-232 - interface.



Reception addressing has been set OFF.

The radio modem will transfer all received data to the RS-232 interface.

Reception addressing has been set OFF.

The radio modem will consider the characters of the address as a part of the data and will send all the characters to the RS-232 interface.

Reception addressing has been set ON but there is no address in the data packet.

Data will appear on the RS-232 interface ONLY if the first 2 characters of the data match either of its own RX address. The radio modem will remove those 2 characters of data.

10.2.1 Connection between two points

When forming a connection between two points it is recommended that both the reception and transmission addresses are identical in both radio modems. This is the easiest way to control addresses and the risk caused by interference from other systems operating in the same area is minimal.

Example: by setting all addresses of both radio modems to a value '1234', they will accept only those messages which contain this address, and they will use this same value when transmitting data.

If the channel is reserved for use only by the said network, or if the terminal devices are responsible for addressing, it is not necessary to use addressing in the radio modems.

10.2.2 System of one base station and several substations

In systems with several substations, the base station must know to which substation each message is intended, and from which substation each received message originates. Usually terminal devices handle addressing completely, but it is also possible to use the addressing functionality of the radio modems.

For example, if the substation terminal devices are not able to check and form addresses by themselves, addressing may be achieved with the help of the addresses of the radio modems attached to these terminal devices. The base station may, in such a case, define the destination of a message by adding the address of the corresponding radio modem into the beginning of the data packet. The substation radio modem(s) will check the address and the corresponding radio modem will identify and remove the address characters. In a similar way, the substation will add when transmitting to the base station its address characters into the beginning of the data packet, thus defining the origin of the sent data packet. In the base station radio modem, addresses have been switched OFF, so that they are transmitted as is to the base station terminal device for further processing.

10.3 Using repeaters and addresses in the same system

In systems with several repeaters, a substation and a base-station, addresses must be used in radio modems. It is possible to realise also a system with only one repeater without addressing. In such a case, the base station will however hear the message both from the substation and from the repeater, in other words the message is duplicated as it moves along the route.

There are at least two ways of realising such a system depending on the capabilities of the terminal devices in question and on the number of repeaters to be used and on their relative positions to each other.

10.3.1 System with several repeaters

In systems with several serial or parallel-chained repeaters, addressing must be used to prevent messages from ending up in loops otherwise formed by repeaters, and to ensure that only the desired (addressed) radio modem receives the data intended for it.

All radio modems in the network must be set to a state, in which the RX-addressing is switched ON and TX-addressing is switched OFF. Base-station and all substations add an address string in the beginning of the data to be transmitted. In the relaying of the message addressing is used in the following way:

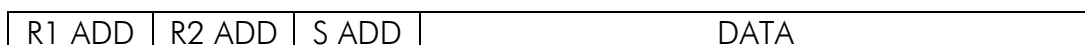

- The above is the data received from the base station terminal device, containing repeater addresses (R1 ADD, R2 ADD) and the substation address (S ADD). Two characters define each address.

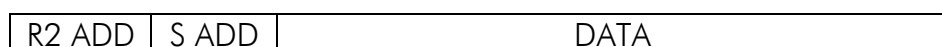

- The above is the same message after being relayed from repeater 1 to repeater 2.

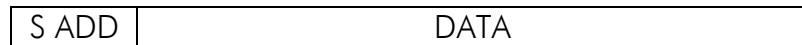

- The above is the same message after being relayed from the last repeater in the chain (repeater 2) to the substation.



- The above is the same message being relayed via the serial interface of the substation radio modem to the terminal device.

In a situation where the substation transmits data towards the base-station the address is formed in a similar way, but the order of the addresses is reversed:

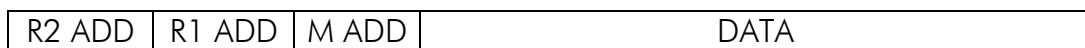

-In the above, R2 ADD is address of repeater 2, R1 ADD is address of repeater 1 and M ADD is the address of the base-station.

10.3.2 Repeater chain using address pairs

In a situation where the terminal devices and substations cannot form address fields, but are able to recognise messages addressed to them, alternating address pairs may be used. Transmit address (TX) and receive address (RX) alternate in the order shown in the table below.

Address type	Base-station address	Repeater 1 and the addresses of the substations of the base-station	Repeater 1 substations addresses
TX-address	Address 1	Address 2	Address 1
RX-address	Address 2	Address 1	Address 2

In a network where alternating addresses are utilised, the exact route that is used to relay a message to a certain radio modem is fixed at the time of installation and configuring the system. The order of the addresses must be the same as the order of the route that is used to relay the message to the said radio modem. It should be noted however, that in network where alternating addresses are used the base-station and substations will hear their own messages repeated.

10.3.3 Repeater chain using dual addressing

If the terminal devices cannot add address chains to the beginning of the data packets, a network with several repeaters may still be realised by using dual addressing. In dual addressing each link (see arrows below in figure) is given a unique address, which will prevent duplication of messages and endless loops in the network. The terminal devices need not add anything to the data.

Usually the primary transmit address is used in transmission (TX1). The secondary transmit address (TX2) is used only if the *Repeater Mode* is used and the packet to be repeated was received using the secondary reception address (RX2).

In the following example two repeaters are used. It should be noted that each link (arrow) might be uniquely defined with the help of radio modem numbers and data transfer directions. The *Repeater Mode* should be switched ON only in the radio modems acting as repeaters to prevent the packets from remaining in endless loops in the network.

Repeaters may also act as ordinary substations; in that case the terminal device must wait until the message has reached the end of the repeater chain before sending data.

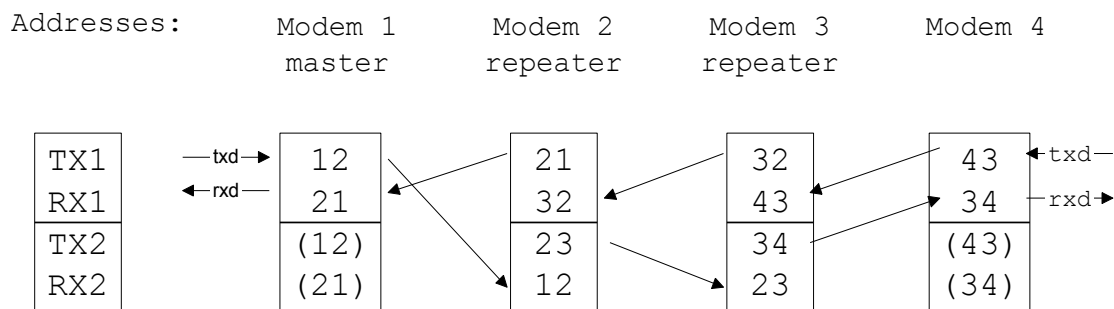

10.3.4 Redundant repeater chain

Reliability of a radio data communication system can be improved significantly by designing redundant equipment setup for master and repeater stations. The two repeater chains are separated by proper dual addressing setup. Slave stations need to be able to communicate with the master through the both repeater chains. By using the "TX address auto switch" function, the slave station modem directs the reply message to the repeater chain from which the request has been received.

If "TX address auto switch" has been set ON, radio modem checks out the RX address of the received message. When one of the RX addresses is recognised, all the messages coming in from the serial interface will be sent to the air with matching TX address. The use of "TX address auto switch" function is not recommended if Repeater Function is set ON.

11 INSTALLATION

11.1 Installation of a Radio Data Modem

The radio modem should be installed with the installation accessories supplied with the radio modem.

NOTE!

When selecting a suitable location for the radio modem it must be ensured that no water can get into the radio modem under any conditions. Direct sunlight is also to be avoided. It is not recommendable to install the radio modem on a strongly vibrating surface. Suitable dampening and/or isolation materials should be used in cases where the installation surface will be subjected to vibration.

11.1.1 RS-232 Wiring

NOTE! In SATELLINE-4Pro the voltage is limited to 16V.

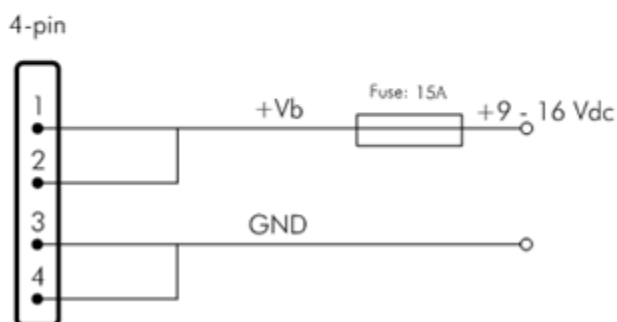
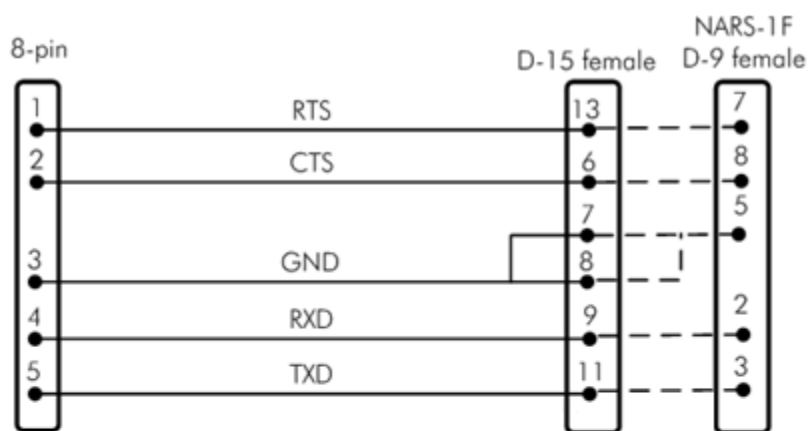

11.1.2 Fuse

A proper fuse must be connected in between the radio modem and the power supply. The correct value is 15A for SATELLINE-4Pro.

11.1.3 Power supply

The allowed operating voltage is +9 ... +16 V_{DC}. The radio modem must only be connected to a power supply with an adequate current output (power rating minimum is 120W). The pins 1 and 2 of the 4pin Odu-connector are connected to the positive power supply line. The pins 3 and 4 are connected to negative power supply line (ground).

11.2 Antenna installation

NOTE!

Because of the great transmission power of **SATELLINE-4Pro** radio modem, only an external antenna is allowed. A whip-antenna directly connected to the antenna connector must not be used.

11.2.1 Mobile equipment

1/4-wave antenna

1/2-wave antenna

The ideal installation position is vertical, and there should be at least 0.5 m of free space around the antenna. In small systems a 1/4-wave antenna is sufficient. A separate ground plane should be placed under the antenna (vehicle rooftop or the engine hood or trunk door are usually suitable). In problematic cases the most suitable type is a 1/2-wave antenna. It can be installed directly at the top of a pipe with the added benefit of gaining as much as free space around the antenna as possible. In cases, which the antenna cannot be directly connected to the TNC-connector of the radio modem, a coaxial cable with 50 ohm impedance must be used between the antenna and the TNC-connector.

11.2.2 Base stations

Omni-directional antennas (1/4- , 1/2- or 5/8-wave antenna)

Directional antennas (yagi /multi-element antenna or corner antenna)

The antenna should be installed in a vertical position. The exact location of the antenna depends on several factors, such as the size of the overall system and the coverage area terrain contours. A rule of thumb is that the base station antenna should be located at the highest point of the coverage area and as close to the centre of the coverage area as possible. The base station antenna can also be located inside a building, if the walls of the building do not contain metal.

11.2.3 General antenna installation instructions

The reliability and the achievable coverage of useful signal strength can be severely affected by the positioning of the antenna. Antenna and cable connectors should have gold-plated pins and sockets, as use of low quality connectors can lead to eventual oxidation of the connector surfaces, which in turn may degrade the contact and cause additional attenuation. Good quality tools and materials must be used when installing radio modems, antennas and cables. The weather tolerance of the materials used must also be taken into account. Installed materials must withstand all foreseeable weather conditions (frost, excess sun, direct UV-radiation, seawater etc.). Also possible environmental pollution must be considered (acids, ozone etc.).

Antennas must be installed well away from metallic objects. In the case of small antennas this distance should be at least ½ m. With large antennas the distance should be >5 m and in case of repeater antenna combinations >10 m.

If the system contains a large number of radio modems, the best location for an antenna is the highest point of a building and possibly an additional antenna mast. If a separate antenna mast is used, the antenna can, if necessary, be installed sideways about 2...3 m from the mast itself.

When installing an antenna possible interference sources must be considered. Such interference sources are, for example:

- mobile telephone network base station antennas
- public telephone network base station antennas
- television broadcast antennas
- radio relay antennas
- other radio modem systems
- PC-related devices (approximately 5 m radius from antenna)

When ordering antennas we request you to note that antennas are always tuned to a specific frequency range. Simple antennas and antennas, which have been constructed of stacked yagi-antennas, are typically rather broadband. As the number of yagi-elements increases the frequency range becomes narrower. Note this specially with 35W.

When designing and installing a system it is advisable to prepare to test the system, and also to consider serviceability of the system. In particular cabling should be planned to allow easy access and to allow for maintenance. It is often practical to use long antenna cables, so that the radio modem can be installed far enough from the antenna itself to a location that is easily accessible (see section 10).

The type of the antenna cable is dependent on the length of the antenna cable, and the following table can be used to select a suitable type:

Length	Type	Attenuation 10m/450MHz
<5m	RG58	3.0dB
>20m	ECOFLEX10	0.9dB
<20m	ECOFLEX15	0.6dB

If there is a line-of-sight path between the antennas a 6 dB power marginal is usually adequate. However, if the connection is built on the reflection and/or the knife-edge diffraction the path loss can vary even 20 dB depending on the weather conditions. In this case a short test can give a too positive result of the quality of the connection. Thus the height of the antennas and topographical obstacles must be surveyed with great care. From time to time a marginal connection can be used if the data transmission protocol is well prepared for this and the data transmission that occasionally slows down does not cause any problems to the system.

Vertical polarised antennas (antenna elements are in vertical position) are often used in radio systems. In a system between a base station and substations vertical polarisation is recommended. The radio modem antenna cannot be mounted on the same level as the other substation antennas in the same building. The best way to distinguish from the other antennas situated in the neighbourhood is to mount the antennas as far as possible from each other on the altitude level. The best result is generally obtained when all the antennas are in the same mast. With an extra ground plane between the antennas more distinction can be obtained between the antennas in the mast.

Horizontal polarisation can be used in data transmission between two points. With the polarisation attenuation more distinction is obtained to vertical polarised systems. The influence of the directional patterns of the antennas must, however, be taken into consideration. If a distinction to another interfering antenna is wanted with the horizontal polarised antennas there must be a good attenuation of the back lobe. In addition to this the interfering radiator should be situated behind the antenna.

When a system does not demand the use of an omni-directional antenna it is recommended that directional antennas are used e.g. two-element yagis in permanent external installations. Please note that as antenna amplification increases the setting of the direction of the antenna requires more attention.

Base stations in high places should be supplied with high-Q cavity filters. Please note that the higher the base station antenna, the larger the coverage area and in turn that the risk of interference is also increased.

SATEL recommends the use of a band-pass filter with a large Q in the antenna cable of the base station.

Example of an antenna installation: by using amplifying antennas (G =Gain) and by installing the antenna high, long connection distances can be realised using the SATELLINE-4Pro radio modem.

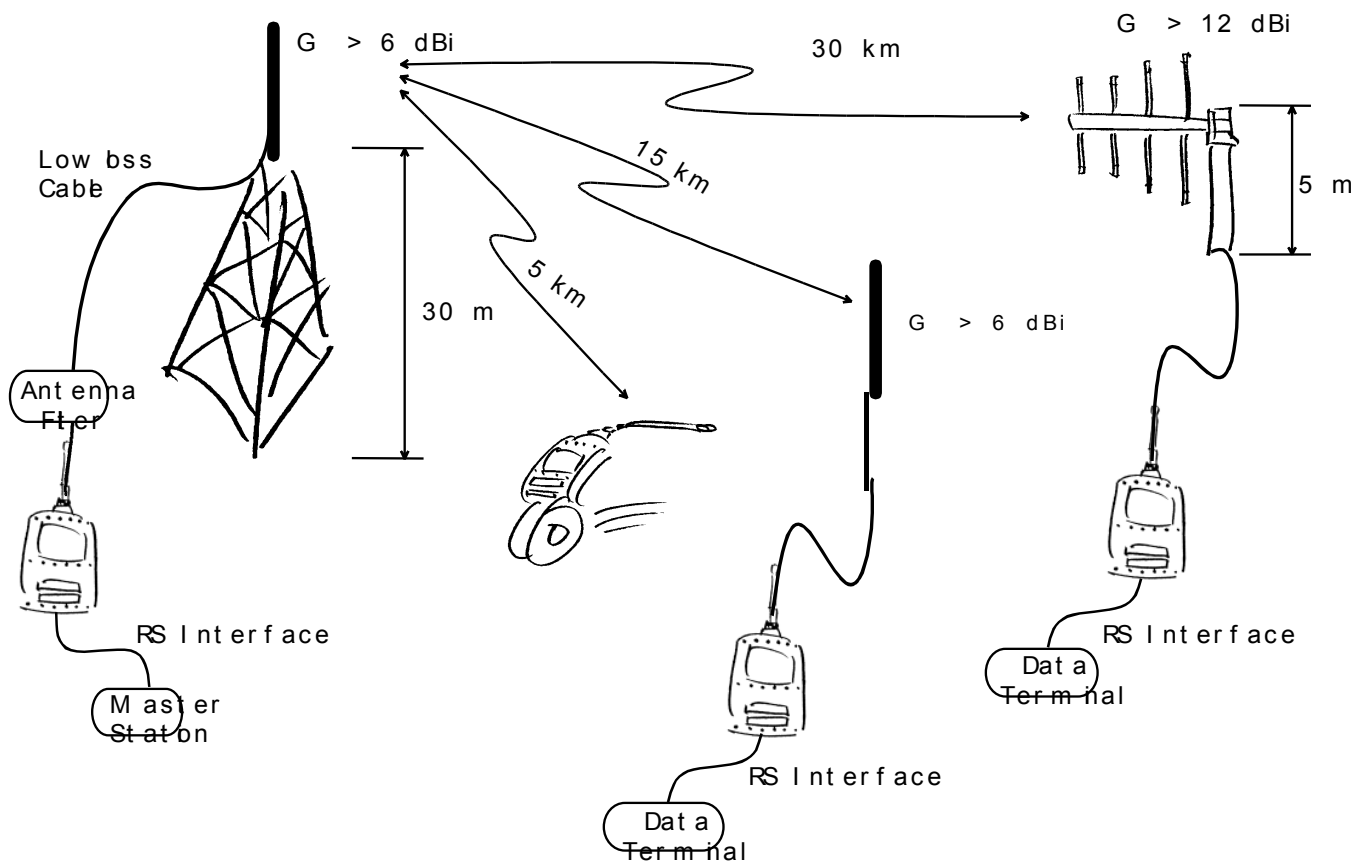

12 DESIGNING SYSTEMS

12.1 Factors affecting the quality and distance of the radio connection

- Power of the radio transmitter
- Sensitivity of the radio receiver
- Tolerance of spurious radiation's of the radio modulating signal
- Amplification of transmitting and receiving antennas
- Antenna cable attenuation
- Antenna height
- Natural obstacles
- Interference caused by other electrical equipment

The transmitter power of the SATELLINE-4Pro is 35 W (maximum) and the sensitivity of the receiver better than -114 dBm. Thus in a flat area and in free space with a 1/4 wave antenna (antenna amplification 1dBi) and antenna height of 1 m communication distances of 3 to 4 km can be achieved. Distances may be considerably shorter in situations where there are metallic walls or other material inhibiting the propagation of radio waves.

Over long distances, increasing the height of antennas can often solve problems caused by natural obstacles. A ten-fold increase in distance can be achieved with the use of amplifying antennas. Frequent topographical variations over long distances may require that at least one of the antennas be raised to a height of 10 to 20 m.

If the antenna cable is more than 10 meters long it is necessary to use a low loss cable (< 0.7 dB /10 m) in order not to waste the antenna amplification. Adding a repeater station can also solve problematical radio connections. In systems with many base stations the RSSI-signal can be used to assist in choosing the base station with the best signal. A communications network can also be built with a combination of cables and radio data modems.

The SATELLINE-4Pro operates in the 450 MHz band, where man made interference is insignificant. Long distance interference needs not to be taken into account even in special weather conditions.

The SATELLINE-4Pro tolerates normal levels of interference that occur. However, exceptionally high levels of interference can break through the safeguards and thus cause errors in data transfer. In mobile vehicle applications the range of operation can be increased by dividing the transmitted data into e.g. 50...500 byte long blocks and by re-transmitting the defected blocks.

A sufficient safety margin can be obtained by testing the communication path using extra 6 dB attenuation at the antenna connection and with slightly less effective antennas than those to be used in the final system.

12.2 Radio field strength

Radio signal strength must be good enough for successful data transfer. Where field strength is above a certain level, the operational results are very good. Below this level, a few dB marginal areas occur in which errors begin to be generated by noise and interference that will eventually lead to loss of connection.

The field strength is at its optimum level in open space, although increasing distance will still reduce it. It must also be remembered that one open space has different environmental and external factors to another, and that the effects on transmission quality must be taken into account when planning the system.

Ground, ground contours and buildings cause attenuation (loss of energy through absorption) and reflection of radio waves. Buildings reflect radio waves and therefore the affects of attenuation are not as acute when transmission is over a short distance.

However, the reflected waves will often be a bit delayed, and when they combine with the direct radio waves they interact in either a weakening or a strengthening way. This causes the fading effect in mobile systems. In reality very sharp signal drops spaced about 35 cm apart may occur. The attenuation may even reach 40 dB, normally less.

13 CHECK LIST

The following points must be taken into account when installing and configuring a radio modem:

1. All operating voltages of all the equipment concerned must always be switched OFF before connecting the serial interface cable.
2. When considering the exact placement of a radio modem and/or its antenna, the following points must be taken into account to guarantee optimal results:
 - The antenna should be installed in open space as far as possible from any possible sources of interference
 - The radio modem should not be installed onto a strongly vibrating surface
 - The radio modem should be installed in such a way as to minimise exposure to direct sunlight.
3. To ensure reliable operation the voltage output of the power supply used must be stable enough and the current capability of the power supply must be sufficient.
4. The antenna must be installed according to instructions.
5. *Serial interface settings between the radio modem and the terminal unit must correspond to each other.*
6. All radio modems in the same system must be configured using equal radio settings (radio frequency, channel spacing, compatibility, forward error correction and data field length).

14 ACCESSORIES

14.1 RS-232 cables and adapters

Type	Description
YC0368 CRS-35W 8-pin	2 m cable, ODU 8-pin / D9 female
YC0369 CRS-35W 8-/7-pin	2 m cable, ODU 8-pin / ODU 7-pin male
YC0359 CRS-35W 8-/8-pin	2 m cable, ODU 8-pin / ODU 8-pin male
YC0374 CRS-35W 8-/8-pin (0/30)	2 m cable, ODU 8-pin (0 deg) / ODU 8-pin male (30 deg)
YC0240 NARS-ST	ODU 8-pin / D15 female

Contact SATEL Oy for more detailed information about other serial interface cable options.

14.2 Power cables and supply

Type	Description
YC0355 C-P-35W 2m	2 m cable, ODU 4-pin male / 4mm lab plugs
YC0353 C-P-35W 3m	3 m cable, ODU 4-pin male / Alligator clip
YC0352 C-P-SAE 35W-4pin	2 m cable, ODU 4-pin male / SAE connector
YC0150 Power Adapter 150W	ODU 4-pin male, IN 100-2410 Vac, OUT 12 Vdc / 12.5 A
YC0904 Mains Cable C-M	For YP0150 power supply with Europlug

Contact Satel Oy for more detailed information about other power cable options.

14.3 RF-cables

Type	Description	Length	Note
YC1101 CRF-1	Cable with TNC m /TNC f-connectors	1 m	RG58 (3 dB/10 m)
YC1105 CRF-5F	Cable with TNC m /TNC f-connectors	5 m	RG58 (3 dB/10 m)
YC1106 CRF-5M	Cable with TNC m /TNC m-connectors	5 m	RG58 (3 dB/10 m)
YC1004 ECOFLEX10	Low loss cable	X	0.9 dB/10 m
YC1005 ECOFLEX15	Low loss cable	X	0.6 dB/10 m

Note! In the description, m=male, f=female connector type.

14.4 Antennas

Type	Description
CA420O	Omnidirectional coaxial dipole, 2 dBi, 405-440 MHz
CA450O	Omnidirectional coaxial dipole, 2 dBi, 440-475 MHz
CA405GP+	Omnidirectional ground plane, 6 dBi, 401-409 MHz
CA410GP+	Omnidirectional ground plane, 6 dBi, 406-414 MHz
CA420GP+	Omnidirectional ground plane, 6 dBi, 416-424 MHz
CA430GP+	Omnidirectional ground plane, 6 dBi, 426-434 MHz
CA435GP+	Omnidirectional ground plane, 6 dBi, 431-439 MHz
CA440GP+	Omnidirectional ground plane, 6 dBi, 436-444 MHz
CA445GP+	Omnidirectional ground plane, 6 dBi, 441-449 MHz
CA450GP+	Omnidirectional ground plane, 6 dBi, 446-454 MHz
CA460GP+	Omnidirectional ground plane, 6 dBi, 456-464 MHz
CA470GP+	Omnidirectional ground plane, 6 dBi, 465-475 MHz
CA400Y	Directional yagi, 6 dBi, 380-410 MHz
CA420Y	Directional yagi, 6 dBi, 405-440 MHz
CA450Y	Directional yagi, 6 dBi, 440-475 MHz
CA400Y+	Directional yagi, 8 dBi, 380-410 MHz
CA420Y+	Directional yagi, 8 dBi, 405-440 MHz
CA450Y+	Directional yagi, 8 dBi, 440-475 MHz

Satel antenna selection includes also directional and/or omni-directional antenna. These can be supplied separately on request.

14.5 Filters and lightning protectors

If a radio modem system is installed in an environment that contains high-power transmitters or sources of radio frequency interference, it is highly recommendable to insert suitable filters between each radio modem and its antenna. If a station is installed to a location exposed to lightning, it is recommended to insert a lightning protector to the feed-line outside the protected zone. SATEL Technical Support can give guidance in the selection of suitable products.

15 APPENDIX A

ASCII CHARACTER TABLE																	
D	H	A	D	H	A	D	H	A	D	H	A	D	H	A	D	H	A
0	0	NUL	43	2B	+	86	56	V	129	81		172	AC		215	D7	
1	1	SOH	44	2C	,	87	57	W	130	82		173	AD		216	D8	
2	2	STX	45	2D	-	88	58	X	131	83		174	AE		217	D9	
3	3	ETX	46	2E	.	89	59	Y	132	84		175	AF		218	DA	
4	4	EOT	47	2F	/	90	5A	Z	133	85		176	B0		219	DB	
5	5	ENQ	48	30	0	91	5B	[134	86		177	B1		220	DC	
6	6	ACK	49	31	1	92	5C	\	135	87		178	B2		221	DD	
7	7	BEL	50	32	2	93	5D]	136	88		179	B3		222	DE	
8	8	BS	51	33	3	94	5E	^	137	89		180	B4		223	DF	
9	9	HT	52	34	4	95	5F	_	138	8A		181	B5		224	E0	
10	A	LF	53	35	5	96	60	`	139	8B		182	B6		225	E1	
11	B	VT	54	36	6	97	61	a	140	8C		183	B7		226	E2	
12	C	FF	55	37	7	98	62	b	141	8D		184	B8		227	E3	
13	D	CR	56	38	8	99	63	c	142	8E		185	B9		228	E4	
14	E	SO	57	39	9	100	64	d	143	8F		186	BA		229	E5	
15	F	SI	58	3A	:	101	65	e	144	90		187	BB		230	E6	
16	10	DLE	59	3B	;	102	66	f	145	91		188	BC		231	E7	
17	11	DC1	60	3C	<	103	67	g	146	92		189	BD		232	E8	
18	12	DC2	61	3D	=	104	68	h	147	93		190	BE		233	E9	
19	13	DC3	62	3E	>	105	69	i	148	94		191	BF		234	EA	
20	14	DC4	63	3F	?	106	6A	j	149	95		192	C0		235	EB	
21	15	NAK	64	40	@	107	6B	k	150	96		193	C1		236	EC	
22	16	SYN	65	41	A	108	6C	l	151	97		194	C2		237	ED	
23	17	ETB	66	42	B	109	6D	m	152	98		195	C3		238	EE	
24	18	CAN	67	43	C	110	6E	n	153	99		196	C4		239	EF	
25	19	EM	68	44	D	111	6F	o	154	9A		197	C5		240	F0	
26	1A	SUB	69	45	E	112	70	p	155	9B		198	C6		241	F1	
27	1B	ESC	70	46	F	113	71	q	156	9C		199	C7		242	F2	
28	1C	FS	71	47	G	114	72	r	157	9D		200	C8		243	F3	
29	1D	GS	72	48	H	115	73	s	158	9E		201	C9		244	F4	
30	1E	RS	73	49	I	116	74	t	159	9F		202	CA		245	F5	
31	1F	US	74	4A	J	117	75	u	160	A0		203	CB		246	F6	
32	20	SP	75	4B	K	118	76	v	161	A1		204	CC		247	F7	
33	21	!	76	4C	L	119	77	w	162	A2		205	CD		248	F8	
34	22	"	77	4D	M	120	78	x	163	A3		206	CE		249	F9	
35	23	#	78	4E	N	121	79	y	164	A4		207	CF		250	FA	
36	24	\$	79	4F	O	122	7A	z	165	A5		208	D0		251	FB	
37	25	%	80	50	P	123	7B	{	166	A6		209	D1		252	FC	
38	26	&	81	51	Q	124	7C		167	A7		210	D2		253	FD	
39	27	'	82	52	R	125	7D	}	168	A8		211	D3		254	FE	
40	28	(83	53	S	126	7E	~	169	A9		212	D4		255	FF	
41	29)	84	54	T	127	7F		170	AA		213	D5				
42	2A	*	85	55	U	128	80		171	AB		214	D6				

16 APPENDIX B

16.1 Functional delays

Function	Delay (ms)
Wakeup time from Power OFF -> Power ON (=ready to receive)	123 ms/typical
Serial interface, turnaround time of RS-232	0
TX-mode: Wakeup time from SLEEP to modem ready (triggered by IRQ-data when Data in TD-input).	60ms, typical
RX-mode: Wakeup time from SLEEP to modem ready (triggered by IRQ-data when Data in TD-input).	40ms, typical
RD - TD turnaround wait, if RX freq. \neq TX frequency.	> 20ms app. > 40 ms recommended for compatibility prior to other EASy-family members.
TD - TD turnaround wait if TX frequency changes.	> 20ms app. > 40 ms recommended for compatibility prior to other EASy-family members.
SL-Ping response time from remote modem	222 ms, modem to modem w/o repeaters

16.2 Transmission related delays

Delay from the end of transmission to the end of reception on the serial interface:

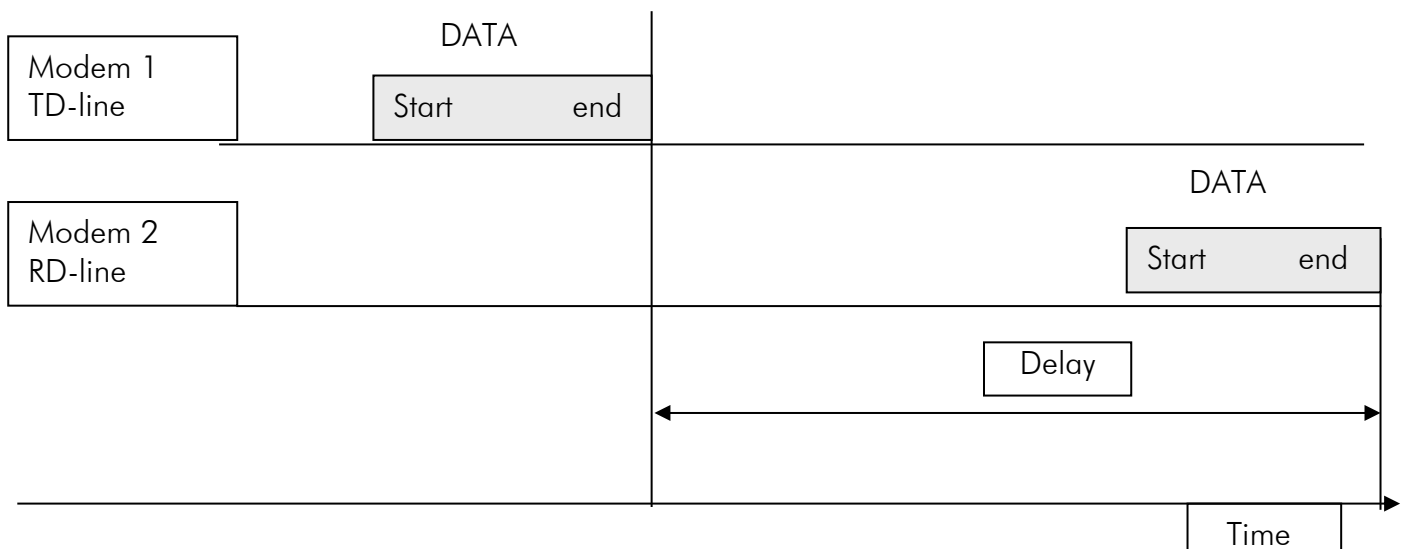

16.2.1 Transmission delays when the radio TX frequency is changed

- If the modem's transmitter frequency (TX) is different than the receiver frequency (RX), there has to be at least 40 ms delay from the Receive Data (RD) to Transmit Data (TD).
- If the transmitter frequency is changed by an SL-command, there has to be at least 40 ms delay after the SL-command before the Transmit Data.
- If the transmitter frequency is changed from TX1 to TX2 by an SL-command during the transmission, there has to be at least 40 ms delay after the SL-command before the Transmit Data.

16.2.2 Transmission delays when using a 12.5 kHz radio channel

Transmission delays without FEC-function (Forward Error Correction).

Number of bytes sent

Bps	1	10	100	500
1200	40	40	29	22
4800	34	34	31	22
9600	32	32	32	27
19200	32	35	64	193
38400	32	36	91	352

Delays are in milliseconds and with a 10% margin.

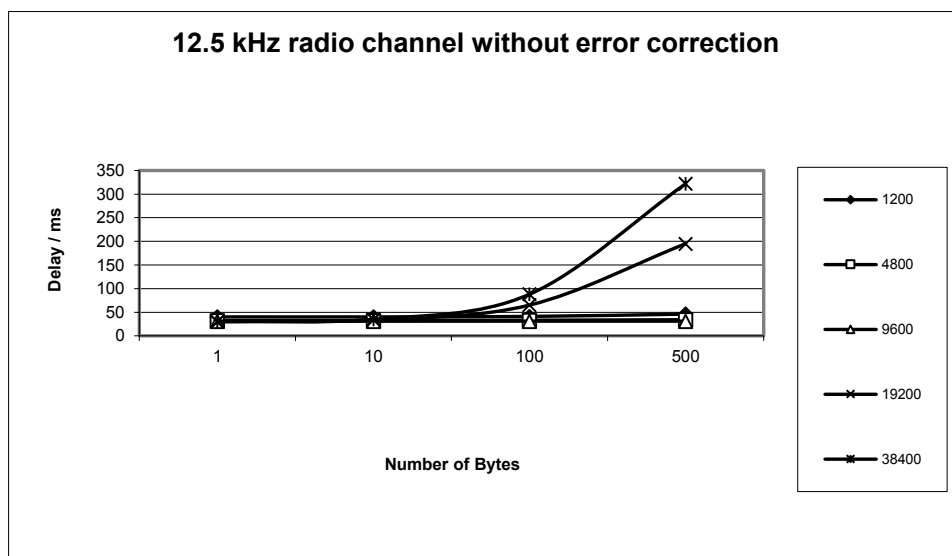

Transmission delays with FEC-function (Forward Error Correction).

Number of bytes sent

Bps	1	10	100	500
1200	52	49	48	50
4800	45	45	44	44
9600	44	44	68	121
19200	44	44	104	360
38400	48	48	132	496

Delays are in milliseconds and with a 10% margin.

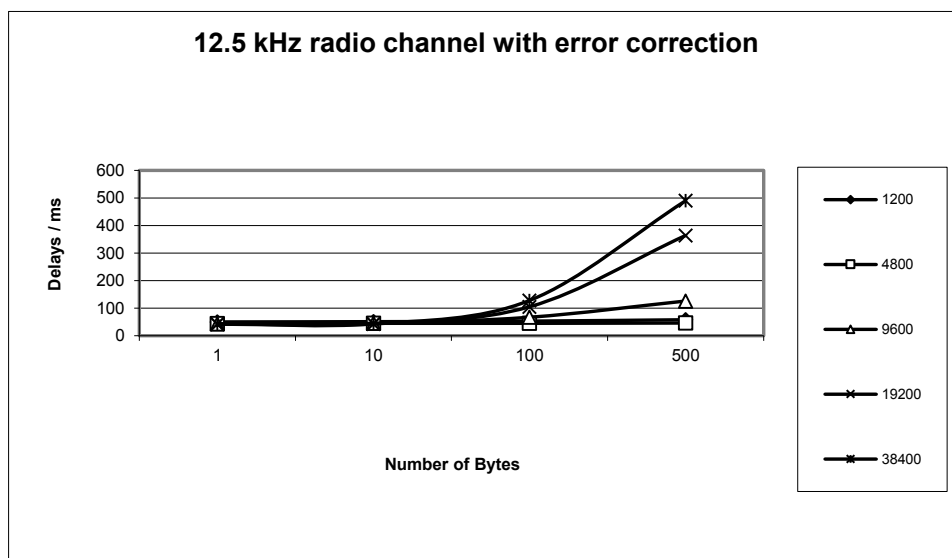

16.2.3 Transmission delays using a 25 kHz radio channel

Transmission delays without FEC-function (Forward Error Correction).

Number of bytes sent

Bps	1	10	100	500
1200	30	30	18	16
4800	23	23	21	12
9600	23	23	21	17
19200	22	22	22	19
38400	22	22	38	102

Delays are in milliseconds and with a 10% marginal.

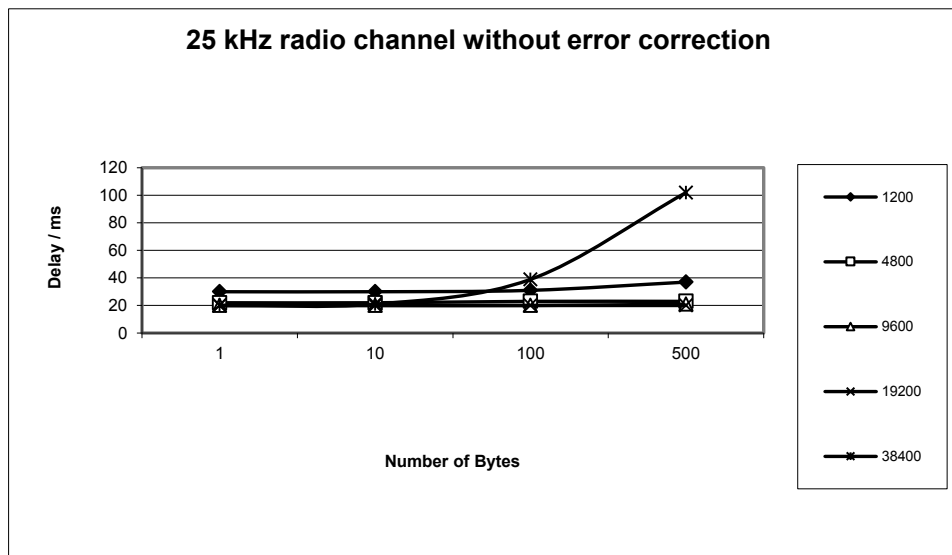

Transmission delays with FEC-function (Forward Error Correction).

Number of bytes sent

Bps	1	10	100	500
1200	35	34	29	30
4800	28	28	27	23
9600	28	28	28	23
19200	28	28	36	64
38400	27	27	58	185

Delays are in milliseconds and with a 10% margin.

